



# Archery Canada Rule Book

## Book 2

## Events

Version 2024.02.05 - EN

Left Blank for Printing

# Book 2

# Events

**Version 2024.02.05 - EN**

This version supersedes all previous versions.

# Table of Contents

<b>INTRODUCTION .....</b>	<b>1</b>
ORGANIZATION: .....	1
FORMAT OF CONSTRUCTION:.....	1
OTHER RECOGNIZED RULES .....	1
DEFINITIONS .....	2
<b>CHAPTER 3 - WORLD CHAMPIONSHIPS .....</b>	<b>4</b>
AC 3.0 ARCHERY CANADA CHAMPIONSHIPS .....	4
3.1. WORLD CHAMPIONSHIPS .....	5
3.2. CONTINENTAL CHAMPIONSHIPS .....	6
3.3. DATES .....	6
3.4. ALLOCATION OF CHAMPIONSHIPS .....	6
3.5. MANAGEMENT STRUCTURES.....	7
AC 3.5. MANAGEMENT STRUCTURES – CANADIAN CHAMPIONSHIPS .....	9
3.6. INVITATIONS .....	10
AC 3.6. INVITATION AND REGISTRATION.....	10
3.7. ENTRIES .....	10
AC 3.7. ENTRIES.....	12
3.8. ACCREDITATION.....	13
AC 3.8. ACCREDITATION.....	13
3.9. CHAMPIONSHIP DOCUMENTS .....	14
AC 3.9. CHAMPIONSHIP DOCUMENTS .....	14
3.10. DIRECTOR OF SHOOTING .....	14
AC 3.10. DIRECTORS OF SHOOTING .....	15
3.11. TOURNAMENT JUDGE COMMISSION .....	15
AC 3.11. TOURNAMENT JUDGE COMMISSION .....	16
3.12. ROLES AND RESPONSIBILITIES OF JUDGES .....	17
3.13. JURY OF APPEAL.....	18
3.14. SCORERS .....	19
AC 3.14 SCORERS .....	20
3.15. DRAW FOR SHOOTING POSITIONS.....	20
AC 3.15. DRAW FOR SHOOTING POSITIONS AND ATHLETE NUMBERS.....	20
3.16. REPOSITIONING ON TARGETS .....	20
AC 3.16. REPOSITIONING ON TARGETS .....	21
3.17. EQUIPMENT INSPECTION.....	21
AC 3.17 EQUIPMENT INSPECTION.....	21
3.18. CHAMPIONSHIP TOURNAMENTS .....	22
AC 3.18. CANADIAN CHAMPIONSHIPS AND MAJOR AC TOURNAMENTS.....	22
3.19. PROGRAMME AND PROTOCOL .....	26
AC 3.19 PROGRAMME AND PROTOCOL – CANADIAN CHAMPIONSHIPS .....	26
3.20. EQUIPMENT ALLOWED ON THE FIELD OF PLAY.....	26
AC 3.21 EXCLUDED DIVISIONS – CANADIAN CHAMPIONSHIPS.....	27
<b>CHAPTER 4 - COMPETITIONS.....</b>	<b>28</b>
4.1. DISCIPLINES.....	28
AC 4.1. DISCIPLINES.....	28
4.2. CLASSES .....	28
AC 4.2. CLASSES.....	28
4.3. DIVISIONS.....	30
AC 4.3. AC DIVISIONS .....	31
4.4. CATEGORIES .....	32
AC 4.4. CATEGORIES (CANADA) .....	33
4.5. ROUNDS .....	33
4.5.1. OUTDOOR ARCHERY ROUNDS.....	33
4.5.2. INDOOR ARCHERY ROUNDS.....	35

4.5.3. FIELD ARCHERY ROUNDS.....	36
4.5.4. SKI-ARCHERY.....	39
4.5.5. FLIGHT.....	39
4.5.6. 3D ROUNDS.....	39
AC 4.5 ROUNDS.....	41
4.6. EVENTS AND TOURNAMENTS.....	48
4.7. WORLD ARCHERY EVENTS.....	49
AC 4.7 ARCHERY CANADA EVENTS.....	50
4.8. OFFICIAL RECOGNITION OF TOURNAMENTS.....	51
AC 4.8 OFFICIAL RECOGNITION OF ARCHERY CANADA TOURNAMENTS.....	52
<b>CHAPTER 5 - TITLES AND RECORDS.....</b>	<b>53</b>
5.1. WORLD CHAMPIONSHIP TITLES.....	53
AC 5.1 CANADIAN CHAMPIONSHIP TITLES.....	54
5.2. WORLD RECORDS - DEFINITION.....	55
AC 5.2 CANADIAN RECORDS - DEFINITION.....	55
5.3. WORLD RECORDS.....	55
AC 5.3 CANADIAN RECORDS.....	56
5.4. WORLD RECORD TOURNAMENTS.....	58
AC 5.4 CANADIAN RECORD TOURNAMENTS.....	59
5.5. CONFIRMATION OF WORLD RECORDS.....	59
AC 5.5 CONFIRMATION OF CANADIAN RECORDS – PROCEDURES.....	60
5.6. OLYMPIC RECORDS.....	61
5.7. CONFIRMATION OF OLYMPIC RECORDS.....	61
AC 5.8 ELIGIBILITY FOR CANADIAN RECORDS.....	61
AC 5.9 PUBLICATION OF CANADIAN RECORDS.....	62
<b>CHAPTER 6 - MEDALS, TROPHIES AND PERFORMANCE AWARDS.....</b>	<b>63</b>
6.1. MEDALS.....	63
AC 6.1 MEDALS - CANADA.....	63
6.2. PRIZES AND TROPHIES.....	63
AC 6.2 PRIZES AND TROPHIES - CANADA.....	63
6.3. PERFORMANCE AWARDS.....	63
AC 6.3 PERFORMANCE AWARDS.....	65
6.4. EVENTS FOR PERFORMANCE AWARDS.....	65
6.5. APPLICATIONS FOR AWARDS.....	66
AC 6.5. APPLICATIONS FOR AWARDS - CANADA.....	66
<b>CHAPTER 7 - FIELD OF PLAY SETUP - TARGET ROUNDS.....</b>	<b>68</b>
7.1. FIELD OF PLAY LAYOUT.....	68
7.2. VENUE EQUIPMENT AND SCORING ZONES.....	70
<b>CHAPTER 8 - FIELD OF PLAY SETUP - FIELD ARCHERY.....</b>	<b>81</b>
8.1. COURSE LAYOUT.....	81
8.2. VENUE EQUIPMENT AND SCORING ZONES.....	83
<b>CHAPTER 9 - FIELD OF PLAY SETUP - 3D ARCHERY.....</b>	<b>86</b>
9.1. COURSE LAYOUT.....	86
AC 9.1 COURSE LAYOUT – CANADIAN OUTDOOR 3D.....	87
9.2. VENUE EQUIPMENT AND SCORING ZONES.....	88
AC 9.3 RANGE LAYOUT – CANADIAN INDOOR 3D AC 9.3.0.....	89
AC 9.4 GRAND PRIX LAYOUT.....	90
<b>CHAPTER 10 - SHOOTING CONTROL AND SAFETY IN TARGET ARCHERY.....</b>	<b>91</b>
<b>APPENDIX AC 3.1 - CANADIAN NATIONAL CHAMPIONSHIP ROTATION SCHEDULE.....</b>	<b>92</b>
<b>APPENDIX AC 3.2 - CANADIAN OUTDOOR TARGET CHAMPIONSHIP REGULATIONS.....</b>	<b>93</b>
<b>APPENDIX AC 3.3 - CANADIAN FIELD CHAMPIONSHIP REGULATIONS.....</b>	<b>97</b>

---

<b>APPENDIX AC 3.4 - CANADIAN REGIONAL INDOOR TARGET CHAMPIONSHIP REGULATIONS .....</b>	<b>102</b>
<b>APPENDIX AC 3.5 - CANADIAN OUTDOOR 3D CHAMPIONSHIP REGULATIONS.....</b>	<b>107</b>
<b>APPENDIX AC 3.6 - CANADIAN INDOOR 3D CHAMPIONSHIP REGULATIONS.....</b>	<b>111</b>
<b>APPENDIX AC 3.7 - FRED USHER MEMORIAL CUP REGULATIONS .....</b>	<b>115</b>
<b>APPENDIX AC 3.9 - INDOOR MAIL MATCH REGULATIONS .....</b>	<b>119</b>
<b>APPENDIX AC 3.10 - OUTDOOR MAIL MATCH REGULATIONS.....</b>	<b>122</b>
<b>APPENDIX AC 3.11 - CANADIAN CUP EAST &amp; WEST REGULATIONS.....</b>	<b>125</b>
<b>APPENDIX 1 - WORLD RANKING TOURNAMENTS .....</b>	<b>128</b>
<b>APPENDIX 2 - OLYMPIC GAMES SPECIAL REQUIREMENTS .....</b>	<b>130</b>
<b>APPENDIX 3 - MATCH PLAY CHARTS .....</b>	<b>131</b>

## INTRODUCTION

These books contain the rules, procedures and administrative procedures for archery in Canada as practised by the Federation of Canadian Archers Inc., known as Archery Canada and its member Provincial Sport Organizations and their Registrants. It also contains most laws and bylaws governing archery in the World Archery Federation and its member organizations as they have an interest in Canadian archery.

Archers, clubs and other organizations can practice archery in the forms and by the rules they wish. However, they are encouraged to practice archery by these rules to promote consistency of understanding and practice by archers in Canada and other sports organizations worldwide.

This edition contains all current World Archery laws, bylaws, and Archery Canada rules approved and in effect on the date shown below. There may be interpretations that affect this edition. Please check the World Archery website ([worldarchery.sport](http://worldarchery.sport)) and Archery Canada website ([archerycanada.ca](http://archerycanada.ca)) for a listing of all interpretations which may be in force.

If any question concerning a rule in this rulebook arises from editing errors or differences between the French and English language versions, reference will be made to the original form in which the Archery Canada Board of Directors approved the rule. Where any discrepancies occur between the World Archery Rules in this book and the official World Archery Rule Book, the official World Archery Rule Book will take precedence.

**This version supersedes all previous versions.**

### ORGANIZATION:

The Archery Canada Rule Book has been divided into 6 Books.

Book 1 - Constitution and Procedures	(World Archery & Archery Canada)
Book 2 - Events	(World Archery & Archery Canada)
Book 3 - Target Archery	(World Archery & Archery Canada)
Book 4 - Field and 3D Archery Rules	(World Archery & Archery Canada)
Book 5 - Miscellaneous Archery Rounds and Ski-Archery	(World Archery)
Book 6 - Anti-Doping Rules	(World Archery)

### FORMAT OF CONSTRUCTION:

The articles (rules as passed by the World Archery Congress) are in **black type and Times New Roman font**. The articles (bylaws as passed by the World Archery Board) are in *black type and in Italic Times New Roman font*.

Certain sections of the World Archery Constitution and Rules that are not normally of interest to Canadian archers are not included. In most cases, such exclusions are indicated in the text. The full and current text of the World Archery Constitution and Rules can be obtained on the World Archery website at [worldarchery.sport/rules](http://worldarchery.sport/rules), menu item Home-Rules.

The articles (rules) in blue type, Arial font, indicates the exceptions or additions to the rules of World Archery as they apply to archery in Canada recognized by Archery Canada.

Article numbers preceded by AC indicate Archery Canada rules. Article numbers in **black type** and preceded with no text are, by default, World Archery rules.

AC sections with the same numbers as the WA sections reference the WA sections and express the exceptions or additional information as the WA section.

As used herein, the words "may not", "shall", and "will" are to be interpreted as a mandatory provision.

The masculine or feminine gender used in relation to any physical person shall be understood as including the other gender unless there is a specific provision to the contrary or a logical separation (e.g., the class "Women" only refers to female archers).

Note: Language related to gender and the use of pronouns, along with "Men" or "Women" throughout the Archery Canada rule book, is meant to identify and address specific competition categories as outlined by World Archery Rules. Archers in Canada, for National events, have the right to choose the category in which they most closely identify.

### OTHER RECOGNIZED RULES

Archery Canada's rules of archery and most administrative requirements are based to a large extent on the rules of World Archery.

Archery Canada is the Canadian organization officially affiliated with the International Field Archery Association. IFAA rules can be found online at [www.ifaa-archery.org](http://www.ifaa-archery.org).

Archery Canada rules for the sport of 3D archery are unique for Canada. However, they have a basis on the rules of 3D archery practised by both World Archery and the International Bowhunters Organization (IBO).

This rulebook does not contain the rules of the International Field Archery Association (IFAA), the National Field Archery Association (NFAA – USA), the Archery Shooter's Association (ASA), or the International Bowhunting Organisation (IBO). Readers must refer to the rules published by those organizations for events sanctioned by them.

## DEFINITIONS

(Archery Canada definitions in blue text. World Archery definitions in black text.)

**"AC"** Archery Canada - Federation of Canadian Archers using the brand name Archery Canada.

**"Affiliated Club"** is a registrant of Archery Canada, able to register its members as Registrants, eligible for the insurance program and associated club benefits, which include the opportunity to bid to host national events and participate in national events or to list provincially approved tournaments on the National Tournaments Calendar.

**"Athlete"** means any athlete who participates or is selected to participate in an Event or Competition.

**"Athlete Support Personnel"** means any coach, trainer, manager, athlete representative, agent, team staff member, official, medical or para-medical personnel, family member or any other person employed by or working with an Athlete or the Athlete's Member Association participating in a Competition.

**"Camouflage Colours"** - Are trademarked or other digital designs, whether random or not and regardless of colours used, which consist of natural material camouflage patterns such as bark, twigs, or leaves that are used for the purpose of blending in with natural environments thereby providing less visibility to game, military personnel, or others; Non-traditional camouflage colours such as pinks, blues, bright yellow, etc. in camouflage patterns that are used in designs for the purpose of blending in with natural environments whereby providing less visibility are considered camouflage.

**"Competition"** means an Event or series of Events conducted over one or more days under one ruling body (e.g., World Championships).

**"Competition Rule"** is a law which regulates any of the following:

- the equipment used in competition;
- the procedures used in a competition round;
- the activities of the athlete or athletes during competition;
- any other action that takes place on the field of play during a competition.

**"Club"** is an organization registered as a Provincial/Territorial Archery Association member that offers archery programming for its members recreationally or competitively.

**"DoS"** Director of Shooting.

**"Event"** means a single race, match or contest.

**"Mechanical"** means any method that embodies a plurality of interacting parts, whether such are individual pieces or spring co-joined parts capable of co-operatively acting to affect bow string release by a separating movement of at least one such part relative to another.

**"NSO"** National Sports Organization.

**"OC"** Organizing Committee.

**"Outdoor"** means where the athlete is subject to any two of the following three factors while competing: (i) rain, (ii) wind and (iii) sun. For the avoidance of doubt, (i) shooting out of a window would not be an outdoor event since there would be no rain, sun or wind (0 elements present), (ii) shooting under a roof would not be an outdoor event as only wind applies, (no rain or sun) (1 element present), (iii) shooting in a stadium with roof closed would not be an outdoor event since no wind, rain or sun (0 elements present), (iv)



shooting in a walled stadium with roof open would be an outdoor event (no wind but rain and sun) (2 elements) unless the athletes are shooting under an overhang (0 elements present), (v) shooting with athletes protected from wind (sails, walls) is an outdoor event (no wind but rain and sun) (2 elements present), and (vi) shooting in a stadium would be an outdoor event if the athlete could be subject to both rain and sun (and possibly rain) (2 elements present). The above is not to suggest that walls or sails to block winds are allowed on the field of play.

**"Participant"** means any Athlete, Athlete Support Personnel, judge, referee, delegate, commissioner, jury of appeal member, competition official, Member Association team or delegation member and any other accredited person.

**"PTSO"** Provincial/Territorial Sport Organization member of Archery Canada.

**"Qualification Round"** refers to rounds shot to qualify athletes for subsequent events and rank them before elimination and finals matches are shot. These are typically a 720 Round or a round of Field or 3D courses. In some cases, such as common in Canada, where only such rounds are shot for a tournament to determine prizes, and no subsequent elimination or finals match play is shot. The term "Qualification Round" shall mean the round(s) of the tournament used to determine prizes.

**"RSO"** Range Safety Officer, see Book 1, [Appendix 4, AC 1.0](#).

**"Registrant"** An individual who is a registrant (member) of a PSO/TSO member of Archery Canada or otherwise recognized as a registrant (member) of Archery Canada.

**"720 Round"** The 720 Rounds are a composite of outdoor target rounds of 72 arrows that include the rounds described in Book 2, [AC 4.5.1.5](#) to [AC 4.5.1.7](#).

- For Recurve, the WA 70m Round, the 60m Round, and distances for U15 and U13 athletes shot on the 122cm target face.
- For Compound– the WA 50m Round for Compound and distances for U15 and U13 athletes shot on the 80cm target face.
- For Barebow - the WA 50m Round for Barebow and distances for U15 and U13 athletes shot on the 122cm target face.

**"T2S 900 Round"** An outdoor developmental 900 round described in Book 2, [AC 4.5.1.17](#).

**"TD"** Technical Delegate.

**"Traditional"** Regarding archery, bows refer to bows with limbs and risers, of which the recurve bows and longbows are typically representative.

**"Violation"** means a violation of these Rules.

**"WA"** World Archery.

**"Youth Class"** Refers to the Age Classes U21 and younger (i.e., U21, U18, U15, U13, U10).

Rules of target Archery in Canada are consistent with the rules of World Archery except as noted on these pages.

## CHAPTER 3 - WORLD CHAMPIONSHIPS

### AC 3.0 ARCHERY CANADA CHAMPIONSHIPS

#### AC 3.0.1

Canadian Championships

Archery Canada arranges for the annual Canadian Championships:

- Outdoor Target Championships;
- Field Championships;
- Regional Indoor Target Championships;
- 3D Outdoor Championships;
- 3D Indoor Championships.

In addition to Canadian Championships, Archery Canada arranges for and/or organizes other events such as:

- Team Trials;
- Indoor Mail Match, which is an annual indoor tournament held at clubs across Canada;
- Outdoor Mail Match, which is an annual outdoor tournament held at clubs across Canada:
  - and facilitates.
- World Archery Americas, Multisite Indoor Championship of America (MICA).

#### AC 3.0.1.1 Hosting

In order to host any Archery Canada, World Archery Americas, or World Archery registered archery event held in Canada, the host must be an Archery Canada affiliated PSTO or Club.

#### AC 3.0.2.

Provincial and Other Championships

Affiliated Provincial and Territorial Sport Organizations and other affiliated organizations (such as Clubs) may arrange for championship-style events such as:

- Provincial Indoor Target Championship;
- Provincial Outdoor Target Championship;
- Provincial 3D Championship;
- Provincial Games;
- Provincial Mail Matches;
- High School Archery Championship;
- Pan-American Games;
- Canada Games;
- Western Canada Games.

These organizations may organize and operate their events in whatever manner they require. Such events may utilize Archery Canada rules as the basis of the technical specifications and the procedures for their events.

#### AC 3.0.3.

Dates

#### AC 3.0.3.1

Canadian Championships are held each year:

- Outdoor Target Championships at the end of July or in August;
- Field Championships at the end of July or in August;
- Regional Indoor Target Championships on the first full weekend in March;
- 3D Outdoor Championships at end of July or in August;
- 3D Indoor Championships during late winter or early spring.

Note: Dates of Championships may be altered at AC discretion or in unforeseen circumstances.

#### AC 3.0.4.

Allocation of Canadian Championships

**AC 3.0.4.0**

Championships are allocated to a hosting organization(s) within a Province or Territory of Canada according to a list of rotation published by Archery Canada (see [Appendix AC 3.1 - Canadian Championships Rotation Schedules](#)).

**AC 3.0.4.0.1**

The rotation of Championship locations may be periodically altered by the Board of Directors as necessitated by circumstances and according to policy.

**AC 3.0.4.0.2**

All Archery Canada Outdoor Championships (Target, Field, 3D) will be held in the same Province/Region and, as best as possible, should be held in the same area that enables archers to participate in all events.

**AC 3.0.4.1**

Any affiliated club, or a potential host city, can submit a bid to their respective Provincial/Territorial Sport Organization. The Archery Canada Board of Directors will only consider bids supported by the PSO/TSO.

**AC 3.0.4.2**

The bid shall be submitted through the PSO/TSO in writing and shall include the following items, as outlined in the AC Hosting Manual:

- Proposed venue;
- Proposed dates;
- Proposed hosting accommodation;
- Proposed schedule;
- Names of the proposed hosting Club(s) officers of the proposed Organizing Committee;
- Any other information required to complete a hosting agreement.

**AC 3.0.4.3**

The selection of the host Organizing Committee is affirmed by the Board of Directors from the eligible bids supported by the respective PSO/TSO.

**3.1. WORLD CHAMPIONSHIPS****3.1.1.**

World Archery arranges for the organisation of the following Championships:

- World Archery Championships: Recurve and Compound Divisions;
- World Archery Field Championships (optional for Under 21 and Team Event): Barebow, Recurve and Compound Divisions;
- World Archery Youth Championships (Under 21 and Under 18): Recurve and Compound Divisions;
- World Archery Para Championships: Recurve and Compound Divisions;
- World Archery 3D Championships (optional for Team Event): Barebow, Traditional, Longbow and Compound Divisions;
- Target, Indoor and Field Archery for 50+: Barebow (for Field only), Recurve and Compound Divisions (if possible, together with other 50+ events).

And for the divisions as defined in their respective chapters:

- World Archery Flight Championships;
- World Archery Ski Championships;
- World Archery Run Championships.

Despite the above provision, a World Championship does not have to be awarded if the Executive Board determines it is not appropriate.

**3.1.1.1**

*Only World Archery may approve any virtual, online or e-gaming World Championship.*

## 3.2. CONTINENTAL CHAMPIONSHIPS

### 3.2.1.

Continental Associations may arrange for the organisation of Continental Championships.

## 3.3. DATES

### 3.3.1.

World Archery Championships shall be held every two years as follows:

- World Archery in odd years;
- World Archery Field in even years;
- World Archery Youth in odd years;
- World Archery Flight in even years;
- World Archery Ski every year;
- World Archery Run in even years;
- World Archery 3D in even years;
- World Para-Archery in odd years;
- World Archery 50+ in even years.

## 3.4. ALLOCATION OF CHAMPIONSHIPS

### 3.4.1.

Any organisation willing to host a World Championship according to World Archery requirements can submit a bid to the Secretary General through the Member Association of the country in which the championship shall take place.

### 3.4.2.

The bid shall be submitted in writing and shall include:

#### 3.4.2.1.

*The dates.*

#### 3.4.2.2.

*The venue.*

#### 3.4.2.3.

*An assurance that, as far as can be reasonably foreseen, no difficulties shall arise for athletes and officials from any eligible Member Association on grounds of nationality, race, religion or politics and for the free passage through customs of equipment or trophies.*

#### 3.4.2.4.

*A bidding contract signed by all parties and approved by the Executive Board.*

#### 3.4.2.5.

*A guarantee that they shall provide all facilities and comply with all specifications of the respective organising manual in effect at the time of signing the bid contract.*

#### 3.4.2.6.

*A written statement accepting the World Archery Constitution and Rules including the Code of Ethics and Conduct.*

#### 3.4.2.7.

*Any other information required by World Archery.*

**3.4.3.**

The selection of the host country shall be made by Executive Board from the eligible bids, and following a thorough investigation.

**3.4.4.**

If a Member Association has been entrusted with the organisation of a Championship and is unable to hold it or to uphold the commitment under [Article 3.4.2.](#), the Secretary General and all Member Associations shall be informed immediately.

**3.4.4.1.**

*The host Member Association shall be liable for all actual and reasonable expenses directly linked to the failure to host the Championship or to uphold the commitments of [Article 3.4.2.](#)*

**3.4.5.**

The possible reallocation of such a Championship shall be decided by the Executive Board.

**3.4.5.1.**

*If a Member Association wishes to change the location of a Championship it may only do so in exceptional circumstances and with the prior approval of the Co-ordination Committee. If the Co-ordination Committee refuses to approve the change of location, the Member Association shall continue with the original location or World Archery shall remove the Championship. In this case the Member Association shall be liable for all expenses resulting from the change of country or the cancellation of the Championship.*

**3.4.6.**

Congress may establish a maximum limit for the entry fees to World Championships.

**3.5. MANAGEMENT STRUCTURES****3.5.1.**

The Championship is managed by the following committees:

- The Co-ordination Committee;
- The Organising Committee.

**3.5.2.**

The Co-ordination Committee is made up of:

- The World Archery President or the President's representative who shall be the chairperson whose primary function is to protect World Archery's interest in general;
- The Technical Delegate, whose function is to ensure the technical aspects of the Championship are correct;
- The president of the host Member Association or the president's representative;
- The president of the Organising Committee;
- The Secretary General or the Secretary General's representative whose function is to protect World Archery's interest in terms of marketing, television and media and gather information for future championships.

**3.5.3.**

The World Championship is managed by the Co-ordination Committee, which is responsible for:

- The supervision and smooth running of the event;
- The implementation of the laws and bylaws;
- Settling any dispute, complaint or protest which does not concern any other committee, or the Jury of Appeal;
- Taking emergency action to ensure the smooth running of the Championship and protect World Archery's reputation;

- Deciding any other matters not covered in the Constitution and Rules;
- Supervising the organisation of the ceremonies.

#### **3.5.4.**

A Technical Delegate shall be appointed by World Archery to oversee the technical aspects of Championships.

The responsibilities of the Technical Delegate shall be:

##### **3.5.4.1.**

- *Maintain close co-operation with the chairperson of the Co-ordination Committee and with the representative of the Organising Committee;*
- *Serve as liaison person between the Chairperson of the Tournament Judge Commission, the Director of Shooting and the Co-ordination Committee or the Organising Committee;*
- *Advise the organisers on the rules and their implementation;*
- *Inspect the sports facilities and the venue equipment to be used during the competition;*
- *Check that all preparations are in accordance with the rules and the Organisers manual;*
- *Report to the Executive Board on the progress of the preparation of the Championship;*
- *Supervise and attend the draw;*
- *Organise and chair the Team Managers meeting;*
- *Ensure that the rules are observed;*
- *Advise the Co-ordination Committee on necessary changes to protect the best interests of World Archery and the quality of the Championship.*

#### **3.5.5.**

The Organising Committee is responsible for the organisation of the Championship and shall implement the decisions of the Co-ordination Committee.

##### **3.5.5.1.**

*The organisers shall communicate to World Archery 60 days before the Championship the number of press accreditation cards they intend to use.*

#### **3.5.6.**

The Organising Committee shall submit to every Congress, between the date of allocation and that of the Championship, a report on the progress made in the preparations.

#### **3.5.7.**

The Organising Committee is totally responsible for making financial arrangements for the Championship allocated to them in:

- Deciding the amount of entry fees – within the limits set by Congress;
- Bearing the costs of anti-doping control.

#### **3.5.8.**

World Archery shall arrange, in agreement with the Organising Committee, food, lodging and necessary local transportation for the Judges, the cost of which shall be borne by the organisers.

#### **3.5.9.**

The Secretary General shall notify all Member Associations which have entered participants, when a Championship event shall not be held for a category. Member Associations that have entered participants shall be notified of the change no later than 40 days before the first day of shooting.

**3.5.10.**

A results verifier shall be appointed by World Archery to assist the Organising Committee and the Technical Delegate to ensure the validity of target assignments and scoring, and verify results and the publication of the result lists.

**AC 3.5. MANAGEMENT STRUCTURES – CANADIAN CHAMPIONSHIPS****AC 3.5.1**

A Canadian Championship is managed by:

- An Organizing Committee in cooperation with an assigned Technical Delegate.

**AC 3.5.2 not used****AC 3.5.3 not used****AC 3.5.4**

A Technical Delegate will be appointed by Archery Canada to oversee each Archery Canada Championship's technical aspects and assist the tournament Organizing Committee in all technical facets of running the event.

**AC 3.5.4.1**

in addition to [Article 3.5.4.1](#), the AC Technical Delegate will:

- Be in constant contact with the OC from the awarding of the event through to the completion of the event (monthly teleconference calls or meetings);
- Technical Delegate will also conduct a site visit in the lead up to the event, no later than 6 weeks before the start of the event;
- Ensure that all entry forms & logos are correct;
- Ensure the organizing committee is aware of all responsibilities;
- Ensure all deadlines are met;
- Supervise Fred Usher Cup set up;
- Supervise the Grand Prix events;
- Ensure the field of play is set at the correct layout and target arrangements are correct for different categories;
- Monitor scorekeeping and result reporting.

**AC 3.5.5**

The Organising Committee is responsible for the organisation of the Championship and shall implement the decisions of the Technical Delegate.

**AC 3.5.6.**

The Organising Committee shall submit to every Board of Directors meeting between the date of allocation and that of the Championship a report on the progress made in the preparations.

**AC 3.5.7.**

The Organising Committee is totally responsible for making financial arrangements for the Championship allocated to them:

- Archery Canada sets the fees, but the OC can negotiate an increase/decrease to the fees within a reasonable time frame;
- Other financial requirements are specified in the OC/AC Hosting Agreement.

**AC 3.5.8.**

The Organising Committee shall arrange, in agreement with AC, food, lodging and necessary local transportation for the Judges, the cost of which will be borne by Archery Canada. The OC is expected to attempt to negotiate complimentary rooms to cover some of the judges' accommodation.

AC is responsible for all costs related to the TD, excluding transport to and from the venue and to and from the airport.

**AC 3.5.9.**

The Organizing Committee shall notify all registering competitors when a Championship event shall not be held for a category. Such notification will be included on the registration form.

## 3.6. INVITATIONS

### 3.6.1.

Invitations shall be distributed to Member Associations eligible to compete, Honorary Officers, the Executive Board and the respective Permanent Committee.

#### 3.6.1.1.

*At least six months before the first day of competition, the organisers shall issue:*

- *Invitations to Member Associations eligible to compete;*
- *Detailed information on the entry fees;*
- *Preliminary entry forms requesting the numbers of expected participants and officials for each event;*
- *Final entry forms requesting names of participants entered for each event, and of officials;*
- *Information on accommodation, booking arrangements, meals, costs, etc.*

#### 3.6.1.2.

*At least three months before the first day of competition, the organisers shall send to eligible Member Association confirmation that the Championships shall be held as announced.*

## AC 3.6. INVITATION AND REGISTRATION

### AC 3.6.1

Invitations shall be published on the AC website to all registrants eligible to compete.

#### AC 3.6.1.1

At least six months before the first day of the competition, the organisers shall issue:

- Invitations to Registrants eligible to compete;
- Detailed information on the entry fees;
- Entry forms requesting names and other pertinent information of participants;
- Information on schedule, accommodation, booking arrangements, meals, costs, etc.;
- Information on available categories (see. [Article AC 3.21 Excluded Divisions](#));
- Information on dress regulations (see Book 3, AC 20).

#### AC 3.6.1.2

At least three months before the first day of the competition, the organisers shall publish a confirmation that the Championships shall be held as announced. Due to unforeseen circumstances (such as a pandemic), the three-month deadline may be altered.

## 3.7. ENTRIES

### 3.7.1.

All Member Associations in good standing (see [Book1, Appendix 1, Article 3.1.6.](#)) may enter athletes.

#### 3.7.1.1.

*Member Associations wishing to enter athletes in a Championship shall register as follows:*

- *Submit preliminary entries, which is mandatory, not later than 90 days before the first day of competition;*
- *Submit final entries not later than 20 days before the first day of competition;*
- *Member Associations which send final entries that are more than two (four for Youth) athletes different from the numbers indicated in the preliminary entries shall pay a fine established by the Executive Board;*
- *Teams that enter after the 20 day deadline or make changes after this deadline shall pay a penalty of 150 CHF per change or athlete registered;*
- *Under no circumstances shall World Archery accept any entries after the Team Managers meeting or the official practice, whichever comes first.*



**3.7.1.2.**

*Entries submitted after the specified closing date may be refused by the organisers or World Archery; however, if the cause of the delay is due to circumstances beyond the control of the Member Association concerned, the organisers and World Archery may accept that entry. World Archery reserves the right to refuse any entry after the 20 day deadline if such entry would cause a change in the programme or cause other organisational problems. Such decision shall be taken by the Secretary General after consultation with the Organising Committee.*

**3.7.1.3.**

*Member Association shall pay in full the invoice issued by the Organising Committee before the official practice. In case of failure to pay before the official practice, entries may be refused by the organisers or World Archery in consultation with the organisers, and, in such case, the Member Association shall be temporarily suspended until the amount is paid in full.*

**3.7.2.**

The submission of entry forms implies:

- A declaration that the Member Association is in good standing (see 3.1.6.);
- That all athletes and officials expenses shall be covered by the respective Member Association in case of illness or accident;
- All athletes and officials have signed the Anti-Doping Agreement.

If this is not the case, athletes from that Member Association shall not be eligible to compete in the Championship.

**3.7.3.**

The number of athletes that may be entered by a Member Association is limited.

**3.7.3.1.**

*At World Championships, a Member Association may enter no more than three athletes in each category (see [Book 3, Article 21.12.1.](#) as to the number of VI athletes in certain situations).*

**3.7.3.2.**

*A mixed team consists of one female and one male athlete of the same category.*

**3.7.3.3.**

*The number of officials that may be entered by a Member Association is limited. At World Championships or World Ranking Events, the number of officials will be limited to 50% of the number of athletes registered rounded up. For teams entering one or two athletes, they can enter one Team manager and one coach.*

**3.7.4.**

A World Championship shall not be held for any category for which preliminary entries reflect fewer than 12 individuals and six teams. For the Youth and Para-Archery categories, the minimum numbers shall be eight individuals and four teams.

**3.7.4.1.**

*If fewer athletes/teams are entered than the number required for each match play round (see [Article 4.5. Rounds](#)), byes shall be permitted.*

**3.7.4.2.**

*A match with a bye is a match that does not take place because not enough athletes are entered for a round to provide opponents for each match of that round. The athlete/team with a bye qualifies for the following round.*

**3.7.4.3.**

*Organisers shall ask for the date of birth of each athlete of a Youth Class and formal proof to be provided.*

## AC 3.7. ENTRIES

### AC 3.7.1

All Canadian registrants in good standing meeting eligibility requirements may enter as athletes in championship competitions (see Book 1, AC 2.0 & AC 2.2.10).

[AC Note: *some eligibility requirements for Team Trials and Major Events may be separately published.*]

#### AC 3.7.1.1

Registrants wishing to enter a championship competition shall register as prescribed on the AC website for the particular event.

##### AC 3.7.1.1.1

Registration for the following Championships and Trials shall be by online registration or through other prescribed contact with the Organizers:

- Canadian Outdoor Target Championship;
- Canadian Field Championship;
- Canadian 3D Outdoor Championship;
- Canadian 3D Indoor Championship;

##### AC 3.7.1.1.2

For 3D Events, including but not limited to:

- 3D Outdoor Championships;
- 3D Indoor Championships;
- Nationally registered 3D events.

Registrants are not permitted to enter into multiple categories. For clarification on categories, please see AC 4.4., Book 2

##### AC 3.7.1.1.3

Registration for the Canadian Regional Indoor Championship shall be as prescribed by the host clubs.

##### AC 3.7.1.1.4

Registration for the Fred Usher Memorial Cup is at the same time as individual registration.

- Spots are reserved for the PSO/TSOs until one month prior to the National Championships.
- The remaining spots are allocated on a first come, first serve basis.

#### AC 3.7.1.2

Entries submitted after the specified closing date may be refused by the organizers; however, if the cause of the delay is due to circumstances beyond the control of the registrant concerned, the organisers may accept that entry. Archery Canada reserves the right to refuse any entry after the deadline if such entry would cause a change in the programme or cause other organisational problems. Such a decision shall be taken by the Technical Delegate after consultation with the Organising Committee.

### AC 3.7.2

The submission of an entry implies declarations that:

- The registrant meets the eligibility requirements (see Book 1, AC 2.2.10, Article 2.1,2.2);
- The registrant is in good standing;
- The registrant agrees to participate in anti-doping as required;
- The registrant agrees to abide by the codes of conduct of Archery Canada.

### AC 3.7.3

All coaches at:

- Canadian Outdoor Target Championship;
- Canada Cup East & Canada Cup West;
- Team Canada Selection Trials.

are required to register.

#### AC 3.7.3.1

Coaches must have:

- Archery Canada Coach Membership;

- Safe Sport Training;
- Background Check.

**AC 3.7.3.2**

A nominal registration fee will be charged.

**AC 3.7.4**

A championship shall not be held for any category that is currently an Excluded Division (see [Article AC 3.21](#)). Other provisions of this section, [Article 3.7.4](#), are generally applicable in Canada.

**AC 3.7.4.1**

If fewer athletes/teams are entered than the number required for each match play round (see [Article 4.5. Rounds](#)), byes shall be permitted.

[AC Note: *Byes and Forfeiture*]

**AC 3.7.4.2**

A match with a bye is a match that does not take place because not enough athletes are entered for a round to provide opponents for each match of that round. The athlete/team with a bye qualifies for the following round.

**AC 3.4.7.3**

A forfeited match is a match in which one of the two athletes/teams is not present when the order of shooting is decided (when shooting alternately) or in which one athlete/team is not present at the start of the match (both athletes/teams shooting at the same time). The athlete/team present when the order of shooting is decided or present at the designated target at the start of the match shall be declared the winner of that match.

**3.8. ACCREDITATION****3.8.1.**

The organisers shall issue appropriate accreditation to each participant and official, in accordance with World Archery Accreditation Guidelines:

**3.8.1.1.**

*The proof of accreditation shall be carried at all times on the competition area and shall be shown on request of appropriate officials.*

**3.8.1.2.**

*Only holders of appropriate accreditation shall be allowed onto the relevant parts of the competition area.*

**AC 3.8. ACCREDITATION****AC 3.8.1.**

The organisers shall issue appropriate accreditation to each participant and official.

**AC 3.8.1.3**

The number of accredited officials from any PSO/TSO organization is limited. A Provincial/Territorial Team will have a Team Captain who may be helped by up to 3 assistants or coaches for the first 5 athletes from the province, plus 1 coach for every additional 5 athletes. This includes, in the case of wheelchair athletes, 1 Team Official for every 3 wheelchair athletes from the same province in front of the waiting line.

**AC 3.8.1.4**

Organizers will allocate to each competing athlete an athlete number card which shall be proof of accreditation as a competitor and which shall be worn by the athletes to allow the spectators and others to recognize them. Athlete numbers will remain unchanged throughout the tournament.

**AC 3.8.1.5**

Athlete numbers are to be prominently displayed upright on the athlete's quiver, quiver belt or thigh, visible from behind the shooting position at all times while shooting is in progress.

**AC 3.8.1.6**

Accreditation badges and athlete numbers need not be issued or worn for the Regional Indoor Championship.

## 3.9. CHAMPIONSHIP DOCUMENTS

### 3.9.1.

The organisers are responsible for providing the following documents:

#### 3.9.1.1.

*A programme for the Championship indicating dates, times and venues of all competitions, ceremonies, occasions and services of interest to athletes and official before and during the competition; this programme shall have been approved by the Co-ordination Committee;*

#### 3.9.1.2.

*A list of the target assignments and intermediary and final results at the venue;*

#### 3.9.1.3.

*The final detailed results list shall be distributed by World Archery after the event.*

## AC 3.9. CHAMPIONSHIP DOCUMENTS

### AC 3.9.1.

The organisers are responsible for providing the following documents:

For the Canadian Outdoor Target Championship, the Field Championship, the 3D Indoor Championship and the 3D Outdoor Championship:

#### AC 3.9.1.1.

A programme for the Championship indicating dates, times and venues of all competitions, ceremonies, occasions and services of interest to athletes and officials before and during the competition. This programme shall have been approved by the Technical Director.

For all Championships:

#### AC 3.9.1.2.

Lists of the target assignments and intermediary and final results at the venue;

- Two lists of athletes; one according to equipment division (provided prior to equipment inspection) and the other according to target/group, both including the name and athlete numbers - the target/group list being revised whenever targets/groups are re-assigned;
- Interim results list to be distributed after each round/phase of the competition.

#### AC 3.9.1.3

The final detailed results list shall be submitted to AC for posting after the event.

#### AC 3.9.1.4

Within 2 months of the closing day of the Championships, the Organizers will submit a report on the Championships accompanied by a copy of all of the above documents as well as samples of posters, commemorative badges, photographs, press cuttings and any other item that may be of interest to the archives. The report should include any recommendations to Archery Canada or future Organizers.

#### AC 3.9.1.5

Within 6 months of the closing day of the Championships, the Organizers will send a copy of the detailed income and expenditure sheet of the Championships.

## 3.10. DIRECTOR OF SHOOTING

### 3.10.1.

The Judges Committee shall appoint a Director of Shooting.

#### 3.10.1.1.

*The organisers shall appoint a Deputy Director of Shooting and, if necessary, one or more Assistants.*

#### 3.10.1.2.

*The Director of Shooting, the Deputy Director of Shooting and their Assistants shall not have other tasks during the hours of competition nor take part in the shooting.*

## AC 3.10. DIRECTORS OF SHOOTING

### AC 3.10.1

For the Canadian Outdoor Target Championship: The Organizing Committee, in consultation with the Technical Delegate, will recommend to the Board of Directors a Director of Shooting (DoS).

#### AC 3.10.1.1

With the agreement of the Board of Directors, the Organizers will appoint the DoS and if required, an assistant.

### AC 3.10.2

For other championship events and trials, the Organizing Committee will appoint a Director of Shooting and assistants if needed upon approval of the Technical Delegate.

### AC 3.10.3

For the Canadian Regional Indoor Championship, the OC of the host club will appoint a DoS upon approval of the presiding Chairman of the Judge Commission. This DoS may also be an officiating Judge.

### AC 3.10.4

Practice ranges will also be under the control of a DoS appointed by the OC upon approval of the presiding Chairman of the Judge Commission.

### AC 3.10.5

The Director of Shooting, his Deputy and his Assistants shall not have other tasks during the hours of competition nor take part in the shooting.

## 3.11. TOURNAMENT JUDGE COMMISSION

### 3.11.1.

Judging shall be run by the Tournament Judge Commission.

#### 3.11.1.1.

*For International Events there shall be a minimum of one Judge for every seven targets in the Qualification Round of the Target Championships and for every four targets in the Qualification Rounds of the Field Championships.*

#### 3.11.1.2.

*For other events there shall always be a minimum of one Judge. For every 10 target butts at least one Judge shall be appointed.*

### 3.11.2.

Judges shall be appointed by the Judges Committee.

#### 3.11.2.1.

*The Judges Committee shall notify the names of the appointed Judges to the Secretary General and the organisers no later than 90 days before the first day of the competition. The Judges Committee shall receive confirmation of the Judges' availability before making the appointment.*

#### 3.11.2.2.

*If possible, no more than two Judges shall be appointed from any one Member Association.*

### 3.11.3.

*The Judges Committee shall appoint one additional Judge as chairperson.*

#### 3.11.3.1.

*The Tournament Judge Commission shall co-operate closely with the Technical Delegate.*

#### 3.11.3.2.

*At Field Championships each Judge shall be connected by communication equipment to the central post (see [Article 8.1.1.17.](#) and [Article 9.1.1.12.](#)).*

**3.11.3.3**

*The chairperson shall be allowed to overrule decisions made by the judges which can be identified as mistakes. Overruling shall not be allowed regarding non-appealable issues as the ones described in [Articles 19.2 and 19.3 \(WA Rules Book 3\)](#).*

**3.11.4.**

The chairperson, on behalf of the Tournament Judge Commission, shall present a report on the tournament to the Secretary General.

**AC 3.11. TOURNAMENT JUDGE COMMISSION****AC 3.11.1.**

Judging shall be run by the Tournament Judge Commission.

**AC 3.11.1.0**

Judges shall be at least Provincial Judges for all AC recognized tournaments.

- Appointed judges may be assisted by Local Judges and Provincial Judge Candidates.

**AC 3.11.1.1.**

For Archery Canada Championship events, there shall be a minimum number of Judges appointed for each course or field of play:

- At Canadian Outdoor Target Championships, one Judge for every 10 buttresses;
- At Canadian Field Championship, at least one Judge for every 6 targets on each course;
- At Canadian Indoor or Outdoor 3D Championships, at least one Judge on each course.

**AC 3.11.1.2**

For other events, there shall always be a minimum of one Judge on each field of play or each course:

- For every 10 target buttresses, at least one Judge shall be appointed.
- For every course, at least one Judge shall be appointed.

**AC 3.11.2.**

For the Archery Canada Championships, Canada Cup East and Canada Cup West, the Judges shall be appointed by the AC Board of Directors on the recommendation of the Chairman of the Archery Canada Judges Committee.

**AC 3.11.2.1.**

The Chairman of the Archery Canada Judges Committee shall notify the names of the appointed Judges to the Executive Director, the organisers, and the appointed Judges no later than 90 days before the first day of the competition. The Chairman of the Judges Committee shall receive confirmation of the Judges' availability before making the appointment.

**AC 3.11.2.2.**

If possible, no more than two Judges shall be appointed from any one Member Province.

**AC 3.11.3.**

For the Archery Canada Championships, the Board of Directors shall appoint one additional Judge as chairperson of the Tournament Judge Commission, who shall be at least a National Judge.

**AC 3.11.3.1**

The Tournament Judge Commission shall cooperate closely with the Technical Delegate.

**AC 3.11.1.2.**

At Field and 3D Championships, the Chairman of the Tournament Judge Commission shall have communication with each Judge by communication equipment. (see [Article 8.1.1.14.](#)).

**AC 3.11.4.**

The chairperson, on behalf of the Tournament Judge Commission, shall submit a report on the tournament to the Executive Director.

**AC 3.11.5**

Judges wear a red golf shirt (long or short sleeves), a red or beige ball cap or beige brimmed hat or no hat, and beige pants, shorts or skirt.

With the approval of the Chairman of the Tournament Judge Commission:

- Other uniform clothing provided by the Organizing Committee may be worn;
- On Field and 3D courses, other trousers may be worn.

## **3.12. ROLES AND RESPONSIBILITIES OF JUDGES**

### **3.12.1.**

The Judges' duties are to ensure that the tournament is conducted according to the Constitution and Rules, and in fairness to all athletes.

#### **3.12.1.1.**

*They shall check all distances and the correct layout of the range or courses; the dimensions of target faces and target butts; that the faces are set at the correct height from the ground; that all butts are set at a uniform angle.*

#### **3.12.1.2.**

*They shall check all the necessary venue equipment.*

#### **3.12.1.3.**

*They shall check all athletes' equipment before the tournament and at any time thereafter during the tournament.*

**INTERPRETATIONS: JUDGE RIGHTS TO REQUIRE EQUIPMENT DISASSEMBLY**

#### **3.12.1.4.**

*They shall control the conduct of the shooting and scoring.*

#### **3.12.1.5.**

*They shall consult with the Director of Shooting and the Chairperson of the Tournament Judge Commission on questions which arise regarding the shooting.*

#### **3.12.1.6.**

*They shall handle any disputes and appeals which may arise and, where appropriate, pass them on to the Jury of Appeal.*

#### **3.12.1.7.**

*They shall in liaison with the Director of Shooting interrupt the shooting if necessary because of weather conditions, power failures, a serious accident, or other occurrences, but to attempt, if at all possible, that each day's program is completed on that day.*

#### **3.12.1.8.**

*They shall consider relevant complaints or requests from Team Captains and, where applicable, take suitable action. Collective decisions shall be made by a simple majority of votes. In case of a tie, the chairperson shall have a tie breaking vote.*

#### **3.12.1.9.**

*They shall deal with questions concerning the conduct of the shooting or the conduct of an athlete. These questions shall be lodged with the Judges without any undue delay and in any event shall be lodged before the prize giving. The ruling of the Judges or Jury of Appeal, as applicable, shall be final.*

#### **3.12.1.10.**

*They shall ensure as far as possible that athletes and officials conform to the Constitution and Rules as well as to decisions and directives the Judges may find it necessary to make.*

### 3.13. JURY OF APPEAL

#### 3.13.1.

A Jury of Appeal of three members shall be appointed by the Executive Committee for every World Championships.

#### AC 3.13.1

A Chairman of a Jury of Appeal shall be appointed by the AC Board of Directors for every Championship, trial or major event.

#### AC 3.13.1.1

Upon receipt of an appeal, the Chairman of the Jury of Appeal will appoint two impartial and knowledgeable Jury members who are not involved as a subject of the appeal from the following list (not in any order and not limited to the following):

- A knowledgeable Judge who is present but not competing or officiating;
- A knowledgeable Archery Canada Officer who is not competing;
- A knowledgeable Coach, and if necessary, impartial, knowledgeable competitors in a different category from the appellant.
- The technical delegate should not be a member of the jury.

#### AC 3.13.1.2

For the Canadian Regional Indoor Championship, the Jury of Appeal will consist of the Archery Canada President or designate, the chairperson of the Archery Canada Judge committee or designate and the Vice-President of Archery Canada or designate.

#### 3.13.2.

The decision made by the Jury of Appeal is final.

#### 3.13.3.

Appeals against rulings by the Judges shall be presented, in writing, by Team Managers, or appellants if no Team Manager has been designated.

#### 3.13.3.1. (Also applies to AC events.)

*An intention to appeal when it might affect the progression of an athlete from one stage of the competition to the next, shall be expressed in writing and lodged with the chairperson of the Tournament Judge Commission within five minutes of the end of the relevant round or match, whichever applies. During the Finals of match play rounds, the notice of intent to file an appeal shall be given within five minutes of the end of the match, or prior to the start of the next match, whichever is first.*

#### 3.13.3.2.

*The written appeal shall be lodged with the Jury within 15 minutes of the end of the relevant round or match, whichever applies.*

#### AC 3.13.3.2

The written appeal shall be lodged by Provincial/Territorial Team Captains (or appellants if no Team Captain has been designated) with the Chairman of the Tournament Judge Commission:

- At target events, refer to Articles 3.13.3.1 and 3.13.3.2 above;
- At 3D and Field events:
  - For the qualifications round(s), within 30 minutes after the last archer has returned or the judges have declared the course(s) clear of archers.
  - For Field eliminations and finals, refer to Articles 3.13.3.1 and 3.13.3.2 above;
  - For 3D finals shoot-up, refer to Articles 3.13.3.1 and 3.13.3.2 above.

#### AC 3.13.3.2.1

For the Canadian Regional Indoor Championship, any athlete may make an appeal in writing to the Chairman of the Archery Canada Judge Committee regarding the scores, proceedings or Judge's decisions at any Host Site. Appeals must be received within one week of posting the results from the site involved on the Archery Canada website. Mail or e-mail submissions are acceptable.



The Chairman will review the appeal and, within three (3) days of receiving the appeal, will either convene the three-member Jury of Appeal to consider the matter or advise the appellant that he does not consider the matter suitable for a Jury. In the latter case, the appellant has a further three (3) days to re-submit the appeal to the Chairman. The Chairman will, within three days of receipt of the appeal, convene a Jury of Appeal who will rule on the appeal within three (3) days.

Such appeals must be accompanied by the prescribed fee (see [Article 3.13.4](#)).

No appeals can be made against the value of an arrow.

#### **3.13.4.**

An appeal is subject to a fee that shall be returned if the appeal is upheld or if the Jury of Appeal decides that it is appropriate. The amount shall be determined by the Executive Board on an annual basis.

#### **AC 3.13.4.**

The prescribed fee is currently \$20.00. As per the Appeals Policy, the fee will be reimbursed if the appeal is upheld.

#### **3.13.5.**

As soon as an appeal is received, a communication to the Team Managers shall be made that an appeal has been made and what the appeal is about.

#### **3.13.6.**

Members of the Organising Committee or persons participating in the Championship are not eligible for the Jury of Appeal.

#### **AC 3.13.6.1**

In exceptional circumstances, members of the organizing committee or competitors in a different category from the appellant may be required to serve on the Jury.

#### **3.13.7.**

The Jury shall be available at all times during the Championship, including the day of official practice. During match play competitions the Jury shall be present and available at the competition venue.

#### **AC 3.13.7.1**

The Chairman of the Jury of Appeal or his delegate must be available at the tournament grounds at all times during a Championship, trials or other major events, including official practice, until:

- At target events, 30 minutes after the end of the shooting day;
- At 3D and Field events, 30 minutes after the end of the shooting day.

#### **3.13.8.**

Jury decisions shall be minuted and reported to the appellant, the chairperson of the Tournament Judge Commission and the organisers before the beginning of the next stage of the competition or before the awarding of prizes.

### **3.14. SCORERS**

#### **3.14.1.**

There shall be scorers in sufficient numbers to ensure that each target in a Championship has a scorer.

#### **3.14.1.1.**

*These scorers can be athletes when there is more than one athlete per target. Scorers assigned by the organisers and who do not take part in the shooting, shall not become involved in any discussion regarding the value of an arrow. Two athletes from each group at Field Championships shall be designated as scorers.*

#### **3.14.1.2.**

*The scorers who are not athletes shall work under the supervision of one or more officials appointed by the organisers, who shall be responsible for the correct management of the scoring.*

**3.14.1.3.**

*One or more scoreboards, of sufficient size to show the target number, name, NOC code for Member Association and progressive score of at least the first eight in each event shall be maintained.*

**3.14.1.4.**

*In the case of electronic scoring, manual scorecards shall also be kept. The arrow values and information entered on the manual score cards are the official reference.*

**AC 3.14 SCORERS****AC 3.14.1.3**

Scoreboards may be required according to the hosting agreement or direction of the Technical Delegate.

**3.15. DRAW FOR SHOOTING POSITIONS****3.15.1.**

The organisers shall allocate to each athlete an athletes' number. These numbers shall be worn by the athletes and be shown in the programme to enable the spectators and others to recognise them.

**3.15.1.1.**

*The athletes' number shall remain unchanged throughout the tournament (with the exception of [Article 3.15.1.5.](#)).*

**3.15.1.2.**

*The draw of allocation to targets or shooting groups and the respective athletes' numbers shall be arranged electronically and approved by the Technical Delegate.*

*Women and Men, and when applicable, different divisions, shall be drawn separately. In Field and 3D Championships, athletes from the same nations are to be separated by at least one group whereas in other championships athletes from the same team may all be placed on adjoining targets or shooting groups.*

**3.15.1.3.**

*Substitution of an athlete shall be allowed until the day before official practice.*

**3.15.1.4.**

*Team officials and athletes may attend the draw but shall not have the right to speak.*

**3.15.1.5.**

*For Olympic Games and World Archery Championships: At the end of the Qualification Round the athletes shall be given athletes' numbers depending on the position they have gained in the Qualification Round: 1 – 64 (32, 104) for Individuals. These athletes' numbers are to be worn up to the end of the competition.*

**AC 3.15. DRAW FOR SHOOTING POSITIONS AND ATHLETE NUMBERS****AC 3.15.1.2**

WA rules also apply; however,

In Field and 3D Championships, groups with more than one athlete from the same Club or Province shall have at least one member of the group from another Club or Province who shall be one of the scorers.

**3.16. REPOSITIONING ON TARGETS****3.16.1.**

At Championships, athletes shall be repositioned as follows:

**3.16.1.1.**

*For the Qualification Round, Judges may alter the target assignment so that there shall be no more than one athlete from the same Member Association on one target. Under no circumstances shall more than two athletes from the same Member Association be assigned to a target.*

**3.16.1.2.**

*In Target Archery Championships the athletes shall be seeded into the match play chart (see [Appendix 3 - Match Play Charts](#)) according to the position reached in the Qualification Round.*

**3.16.1.3.**

*At Field Archery Championships, after the first day of the Qualification Round and after each subsequent round, according to the position reached in the previous round. The organisers shall take care that there shall be no more than one athlete from the same Member Association in the same shooting group. However, if this is not possible, under no circumstances shall more than two athletes from the same Member Association be assigned to a target with the exception of the Finals Rounds (semi-finals and finals).*

**3.16.1.4.**

*In 3D Archery the repositioning shall take place after the first Qualification Round and after each subsequent round (until the semi-finals) according to the position reached in the previous round and the principles set forth in [Article 3.16.1.3.](#)*

**AC 3.16. REPOSITIONING ON TARGETS****AC 3.16.1**

In general, the WA rule also applies; however, When athletes are repositioned on target assignments, whether on the basis of ranking from previous rounds or as otherwise required, groups with more than one athlete from the same Club or Province shall have at least one member of the group from another Club or Province who shall be one of the scorers.

**3.17. EQUIPMENT INSPECTION****3.17.1.**

On the day before the first day of competition, the organisers shall arrange, on or near the practice field, for the inspection by the Judges of all the equipment including spares and accessories that each athlete intends to use during the competition of World Championships, Olympic Games, other Games and other Major International Events.

**3.17.1.1.**

*Teams shall be called in alphabetical order and all athletes shall be accompanied by their Team Manager.*

**3.17.1.2.**

*Judges may request equipment to be modified or changed if found to contravene the equipment rules.*

**AC 3.17 EQUIPMENT INSPECTION****AC 3.17.1**

It also applies to all Archery Canada Championship and other AC registered events.

**AC 3.17.2**

Equipment inspection is mandatory for Archery Canada championships, trials, other major events, and other Archery Canada registered events. It may be scheduled during a practice day and/or the day of the competition if there is no practice day.

**AC 3.17.2.1**

Inspection of athlete's equipment may, but need not be repeated for subsequent events on subsequent days (e.g. having inspected for Field Championship, inspection is not necessary for a following Outdoor Target or 3D Championship).

**AC 3.17.2.2**

Additional inspection of the athlete's equipment may be conducted at any time during or after the competition.

## 3.18. CHAMPIONSHIP TOURNAMENTS

### 3.18.1.

The format for the World Archery Championships and World Archery Youth Championships shall be:

- for the Recurve Division, a Qualification Round consisting of a 70m (60m for Under 18) Round followed by an Olympic Round and;
- for the Compound Division, a Qualification Round consisting of a 50m Compound Round followed by the Compound Match Round.

### 3.18.2.

The format for the World Archery Field Championships shall be a World Archery Field Championship Round.

### 3.18.3.

The format for the World Archery 3D Championships shall be a 3D Championship Round.

### 3.18.4.

Archery competitions may be shot at night time provided suitable lighting conditions can be supplied and athletes can practise under such conditions.

### 3.18.5.

The President may adjust the schedule of Championships or Games to accommodate any reasonable requirement of TV broadcasters. Such an adjustment is to be made with the co-operation of the organisers. Any adjustment shall take into account, as a priority, the interests of the athletes who shall be informed of changes as soon as possible.

## AC 3.18. CANADIAN CHAMPIONSHIPS AND MAJOR AC TOURNAMENTS

### 3.18.7.0

Canadian Championships shall not be held simultaneously with any other championship or tournament except:

#### AC 3.18.7.0.1

The Outdoor Target Championship and the Field Championship may be organized together such that there is a common schedule, but in no circumstances can the competition for any category be divided.

#### AC 3.18.7.1 Canadian Outdoor Target Championship

The format of the Canadian Outdoor Target Championship shall be:

- Official Practice and Equipment Inspection followed by the Fred Usher Cup (Day 1);
- Qualifications (Day 2):
  - One (1) individual 720 Qualification/Ranking Round:
    - ◆ As per [Articles AC 4.5.1.5 to AC 4.5.1.7](#) & Article 13.4., Book 3.
- Eliminations and Finals (Day 3):
  - Individual match play:
    - ◆ As per [Article AC 4.5.1.4.](#) & Article 13.4., Book 3.
  - No cut. All competitors advance to the Eliminations.
    - ◆ Eliminations/medal matches will only be held for categories with three (3) or more competitors.
    - ◆ Medals will be awarded based on the qualification round results in categories with fewer than three competitors.
- All Archery Canada equipment Divisions recognised for Outdoor Target Archery Championships apply;
- All Archery Canada age classes except U10 apply.

See Appendix AC 3.2 Canadian Outdoor Target Championship Regulations for additional information.

#### AC 3.18.7.2 Canadian Field Championship

The format of the Canadian Field Championship shall be:

- Qualifications:
  - Two Modified Field rounds:
    - ◆ One unmarked course of 12 targets or 1 unit, as per [Article 8.1.1.9.](#) Unit for Unmarked Course;

- ◆ One marked course of 12 targets or 1 unit, as per [Article 8.1.1.10](#). Unit for Marked Course;
  - Both rounds are shot on the same day.
- Eliminations:
  - Consists of individual match play as per [Articles AC 4.5.3.3.2 to AC 4.5.3.3.7](#).
- Finals:
  - Consists of the final matches as per [Articles AC 4.5.3.3.8, AC 4.5.3.3.8.1 and 4.5.3.3.8.2](#).
    - ◆ Finals matches will only be held for categories with three (3) or more competitors.
    - ◆ Medals will be awarded based on the qualification round results in categories with fewer than three competitors.
- All Archery Canada equipment Divisions recognised for Field Archery Championships apply except Excluded Divisions (see [Article AC 3.21](#));
- All Archery Canada age classes except U10 apply;
- Unless specified, the Canadian Field Championship is shot using World Archery Field Archery rules as found in Books 2 and 4.

See [Appendix AC 3.3 Canadian Field Championship Regulations](#) for additional information.

### **AC 3.18.7.3 Canadian Regional Indoor Championship**

The format of the Canadian Regional Indoor Championship shall be:

- A single (1) Indoor 18 metre Round;
- The competition takes place at numerous various host sites across the country;
- All Archery Canada equipment Divisions recognised for Indoor Target Archery Championships apply except Excluded Divisions;
- All Archery Canada age classes apply:
  - U10 events may be held at individual host sites, but no results will be posted and any awards are the responsibility of the Host Club.

See [Appendix AC 3.4 Canadian Regional Indoor Championship Regulations](#) for additional information.

### **AC 3.18.7.4 Canadian Outdoor 3D Championship**

The format of the Canadian Outdoor 3D Championship shall be as follows:

- Individual Qualifying Round according to [Article AC 4.5.7.0.2.1](#);
- Individual Finals Round according to [Article AC 4.5.7.0.2.2](#);
- Mixed Team Elimination Round according to [Article AC 4.5.7.0.3.2](#);
- Mixed Team Finals Round according to [Article AC 4.5.7.0.3.3](#);
- All Archery Canada equipment divisions recognized for 3D Archery Championships apply except Excluded Divisions (see);
- All Archery Canada age classes apply:
  - U10 events may be held on a separate course, but no results will be posted, and any awards are the responsibility of the Host Club.

See [Appendix AC 3.5 Canadian Outdoor 3D Championship Regulations](#) for additional information.

### **AC 3.18.7.5 Canadian Indoor 3D Championship**

The format of the Canadian Indoor 3D Championship shall be:

Either:

- 4 courses of 20 3D targets, or:
  - 3 courses – one of 26 3D targets and two of 27 3D targets.
- All Archery Canada equipment divisions recognized for 3D Archery Championships apply;
- All Archery Canada age classes apply:
  - U10 events may be held on a separate course, but no results will be posted, and any awards are the responsibility of the Host Club.

See [Appendix AC 3.6 Canadian Indoor 3D Championship Regulations](#) for additional information.

### **AC 3.18.7.6 not used**

**AC 3.18.7.7 The Fred Usher Memorial Cup**

The Fred Usher Memorial Cup is a mixed-team Championship for Provincial/Territorial and Individual Teams with the format:

- Round Robin Elimination Team Matches:
  - Sixteen teams in four pools;
- Semi-finals and Finals consisting of the winners of the four pools;
- Cash prizes for the 1<sup>st</sup>, 2<sup>nd</sup> and 3<sup>rd</sup> place.

**AC 3.18.7.7.1**

16 Team Format (with potential to increase);

- 1 team spot is held for each PTSO:
  - BC, AB, SK, MB, ON, QC, NB, NS, PE, YK and possibly NF and NWT;
  - PTSO spots are reserved until one month prior to National Championships;
- The remaining 6 spots are open on a 'first come, first serve' basis to be composed of Individual Teams:
  - Teams may be predetermined at the time of registration or randomly assigned by the organizing committee.
    - ◆ Participants will be able to identify their preferences at the time of registration;
- All teams are composed of 3 archers from the following classes (U18, U21, Senior, 50+), divisions (Compound, Recurve and Barebow) and gender (Women and Men) and must include a minimum:
  - 1 recurve or barebow and 1 female archer from any age class.

**AC 3.18.7.7.2 - SHOOTING, TIMING & SCORING**

Regardless of class or division, all teams will shoot from 50m on a full 80cm target face:

- Team Matches are shot according to Articles 13.2.2. & 13.2.3., Book3;
- No handicaps;
- Cumulative scoring.

**AC 3.18.7.7.3 - ROUND ROBIN ELIMINATIONS** (new 2020)

The elimination round will be a Round Robin format:

- 16 teams are put in 4 pools of 4 teams:
  - Teams are assigned to the pools by a random draw;

Pool A	Pool B	Pool C	Pool D
1 <sup>st</sup> drawn	2 <sup>nd</sup> drawn	3 <sup>rd</sup> drawn	4 <sup>th</sup> drawn
5 <sup>th</sup> drawn	6 <sup>th</sup> drawn	7 <sup>th</sup> drawn	8 <sup>th</sup> drawn
9 <sup>th</sup> drawn	10 <sup>th</sup> drawn	11 <sup>th</sup> drawn	12 <sup>th</sup> drawn
13 <sup>th</sup> drawn	14 <sup>th</sup> drawn	15 <sup>th</sup> drawn	16 <sup>th</sup> drawn

- teams drawn randomly.

- Each pool shoots a Round Robin format (3 matches):

Pool A		Pool B		Pool C		Pool D	
1 vs. 5	9 vs. 13	2 vs. 6	10 vs. 14	3 vs. 7	11 vs. 15	4 vs. 8	12 vs. 16
1 vs. 9	5 vs. 13	2 vs. 10	6 vs. 14	3 vs. 11	7 vs. 15	4 vs. 12	8 vs. 16
1 vs. 13	5 vs. 9	2 vs. 14	6 vs. 10	3 vs. 15	7 vs. 11	4 vs. 16	8 vs. 12

- 2 points for a win;
- 0 points for a loss;
- No ties in a match:
  - ◆ Ties in a match are broken by a shoot off as laid out in [Article 14.5.2.3.](#), Book 3;
- All Round Robin matches will be shot simultaneously as laid out in [Article 13.2.2.](#), Book 3;
  - At the end of the Round Robin, ties in match points within a pool will be broken by a shoot off as laid out in [Article 14.5.2.3.](#), Book 3.

**AC 3.18.7.7.4 - FINALS** (new 2020)

The Final rounds will consist of:

- The top teams from each pool go into a semi-final grid;

- 1<sup>st</sup> vs. 4<sup>th</sup>, 2<sup>nd</sup> vs. 3<sup>rd</sup> - based on the top team's average match scores of the 3 Round Robin Matches;
  - ◆ Ties in average match scores will be broken on average number 10s per match, followed by average number of Xs.
- Semi-final matches will be shot simultaneously according to [Article 13.2.2.](#), Book 3;
  - ◆ Ties in a match are broken by a shoot-off as laid out in [Article 14.5.2.3.](#), Book 3;
- Match winners go into the Gold/Silver finals match. Match losers go into the Bronze finals match;
  - If time permits, the Gold/Silver and Bronze final matches will be shot using the alternate shooting format according to [Article 13.2.3.](#), Book 3.

#### **AC 3.18.7.7.5 - PURSE** (new 2020)

The purse is based on the registration fee per team, see [Article APP3.7.3.2](#), times the total number of teams registered:

- Total purse (based on 16 teams) is \$3200:
  - 1<sup>st</sup> \$1500 or 15/32<sup>nd</sup> of total purse;
  - 2<sup>nd</sup> \$900 or 9/32<sup>nd</sup> of total purse;
  - 3<sup>rd</sup> \$600 or 6/32<sup>nd</sup> of total purse;
- Cash prizes to be awarded at the time of the medals.

#### **AC 3.18.7.8 Indoor Mail Match**

The Indoor Mail Match is a multi-site indoor competition over a long duration with the following formats:

- A series of Canadian 300 rounds shot at multiple club locations:
  - The results are submitted weekly;
  - The average of the best 6 scores for each competitor or team is used to determine awards.
- There are three events:
  - Individual event by category - athletes compete in all recognized divisions for medals;
  - Individual event by mail match class - athletes compete for awards in each Mail Match class within an assigned Mail Match class based solely on the score achieved regardless of equipment division, age or sex. A total of 7 Gold Medals are available to be won.;
  - Club Team event – athletes participate in teams with mixed categories for team medals.
- All Archery Canada equipment divisions recognized for Target Archery, and all Archery Canada age classes apply;
- Team composition shall consist of at least one (1) finger shooter, at least one (1) release shooter and at least one (1) woman, U21 or younger age or para-archer.

#### **AC 3.18.7.8.1**

All Archery Canada equipment divisions recognized for Indoor Target Archery plus the Traditional division, and all Archery Canada age classes except U10 apply.

#### **AC 3.18.7.8.2**

Team composition shall consist of at least one (1) finger shooter, at least one (1) release shooter and at least one (1) woman, U21 or younger age or para-archer.

See [Appendix AC 3.9 Indoor Mail Match Regulations](#) for additional information.

#### **AC 3.18.7.9 Outdoor Mail Match**

The Outdoor Mail Match is a multi-site indoor competition over a long duration with the following formats:

- A series of 720 rounds shot at multiple club locations:
  - The results are submitted weekly, and;
  - The average of the best 6 scores for each competitor or team is used to determine awards.
- There are two events shot concurrently:
  - Individual event by category - athletes compete in all recognized divisions for medals;
  - Individual event by mail match class - athletes compete for awards in each Mail Match class within an assigned Mail Match class based solely on the score achieved regardless of equipment division, age or sex. A total of 7 Gold Medals are available to be won.

#### **AC 3.18.7.9.1**

All Archery Canada equipment divisions recognized for Outdoor Target Archery and all Archery Canada age classes except U10 apply.

See [Appendix AC 3.10 Outdoor Mail Match Regulations](#) for additional information.

### 3.19. PROGRAMME AND PROTOCOL

#### 3.19.1.

The Programme and Protocol shall be established by the Co-ordination Committee and be published in the invitation to the Championships.

##### 3.19.1.1.

*The programme of a Championships shall include:*

- *eam Managers meeting;*
- *Equipment Inspection;*
- *Official Practice;*
- *Opening Ceremony;*
- *Competition;*
- *Award Ceremonies;*
- *Closing Ceremony;*

*The schedule shall depend on the number of athletes per category and the space available.*

*The programme shall be in accordance with the guidelines of the Organisers Manual.*

### AC 3.19 PROGRAMME AND PROTOCOL – CANADIAN CHAMPIONSHIPS

#### AC 3.19.1.1

In general, the programs of Canadian Championships are similar to 3.19.1.1. above.

#### AC 3.19.1.2

The specific program of Canadian Championships shall be set by the Board of Directors as indicated in the Regulations for the various Championships (refer to [Appendices AC 3.2 – AC 3.10](#)).

### 3.20. EQUIPMENT ALLOWED ON THE FIELD OF PLAY

For Olympic Games and World Championships

#### 3.20.1.

For Olympic Games, World Archery, World Archery Youth, World Archery Para and all International Events, the following Finals field of play rules apply:

##### 3.20.1.1.

The following items for the athlete shall be allowed:

- *two bows;*
- *Equipment as listed in [Book 3 - Chapter 11 - Athletes Equipment](#), with the exception of telescopes.*

##### 3.20.1.2.

The following items for the team official shall be allowed:

- *one belt pack to carry archery accessories for the athlete or team;*
- *one pair of binoculars or spotting scope with tripod.*

[WA INTERPRETATION: USE OF COACH WITHOUT COACH \(15 DECEMBER 2023\)](#)

##### 3.20.1.3.

*In case of inclement weather, necessary protection, in addition to clothing, may be used upon approval by the Technical Delegate (or, in the Technical Delegate's absence, the chairperson of the Tournament Judge Commission) of the event.*



**3.20.2.**

For Olympic Games and World Archery Championships for match play competition, there can be two fields of play, each containing two targets.

**AC 3.21 EXCLUDED DIVISIONS – CANADIAN CHAMPIONSHIPS****AC 3.21.1**

Unless specified herein or in section [Article AC 3.18](#), all Archery Canada recognized equipment divisions will be recognized at the Canadian Championships.

**AC 3.21.1.1**

An equipment division which has had 10 or fewer registrants for 3 consecutive years will not be offered (excluded division) in subsequent years at the:

- Canadian Outdoor Target Championship;
- Canadian Regional Indoor Championship;
- Canadian Field Championship.

**AC 3.21.1.1.1**

Following each Target and Field Championship, the Divisions will be evaluated by the Archery Canada Events Committee for possible exclusion on the basis of the number of registrants in each equipment division and by combining the number of (non-guest) athletes of all age and sex classes registered for that equipment division.

**AC 3.21.1.1.2 (new for 2024)**

For the Outdoor and Indoor 3D Championships, the 3D Committee will decide which Divisions are excluded.

**AC 3.21.1.2**

The following divisions/categories are exempt from exclusion under section AC 3.21.1.1 above:

- Recurve Division (Target & Field);
- Compound Division (Target & Field);
- Barebow Division (Target, Field & 3D);
- Para-archery categories (Target);
- Instinctive <sup>(WA Traditional)</sup> (3D);
- Longbow Division (3D);
- Unlimited U18 (3D);
- Known U18, U15, U13 (3D);
- Youth Traditional categories (3D);
- 50+ Unlimited category (3D);
- others as specified by the Archery Canada Board of Directors.

**AC 3.21.1.3 Excluded Division as of January 1, 2024**

Canadian Outdoor Target Championship:	none.
Canadian Regional Indoor Championship:	none.
Canadian Field Championships:	Fixed Pins, Hunter, Longbow, Instinctive.
Canadian Outdoor 3D Championship:	Fixed Pins.
Canadian Indoor 3D Championship:	Fixed Pins.

**AC 3.21.1.4**

An Excluded Division may be reinstated by a motion of the Archery Canada Board of Directors.

**AC 3.21.1.5**

Excluded Divisions will remain as competitive divisions at other Archery Canada events and for Open Records.

**AC 3.21.2**

Unless otherwise specified in technical packages or duly posted information, all Archery Canada recognized equipment divisions will be recognized at other Archery Canada registered events.

## CHAPTER 4 - COMPETITIONS

### 4.1. DISCIPLINES

#### 4.1.1.

Competition in Archery is held in the following disciplines:

- Outdoor Archery;
- Indoor Archery;
- Field Archery;
- Para-Archery;
- Run Archery;
- Clout Archery;
- Flight Archery;
- Ski Archery;
- 3D Archery.

### AC 4.1. DISCIPLINES

#### AC 4.1.1

The following archery disciplines are commonly practised in Canada and recognized for Championships and Awards:

- Outdoor Target Archery;
- Indoor Target Archery;
- Field Archery;
- Para-Archery:
  - Indoor and Outdoor Target;
- 3D Outdoor Archery;
- 3D Indoor Archery.

### 4.2. CLASSES

#### AC 4.2. CLASSES

[AC Note: *The terms Senior Women and Senior Men are commonly used synonymously with Women and Men.*]

#### AC 4.2.0

References to gender classes of athletes are specific to each gender and may not be taken to include the other gender.

#### 4.2.1.

World Archery recognises the following classes:

- Under 15 Women;
- Under 15 Men;
- Under 18 Women;
- Under 18 Men;
- Under 21 Women;
- Under 21 Men;
- Women;
- Men;
- 50+ Women;
- 50+ Men;
- For Para-Archery, see Book 3, Chapter 21 - Para-Archery.

**AC 4.2.1**

In addition to WA Classes, Archery Canada also recognizes the following classes:

- U10 Women;
- U10 Men;
- U13 Women;
- U13 Men;
- 60+ Women \* †
- 60+ Men \* †

\* 60+ are recognized for awards in 3D competitions only

† 60+ are recognized in Target Archery and Field Archery for open records only

**AC 4.2.1.1**

Para-archers Archery Canada recognises six Para-archery disability classes:

Four are classified by World Archery Classifiers based on physical ability:

- W1 (most severely impaired group);
- W2 (Wheelchair);
- ST (Standing);
- NE (Non-Eligible for para-archery competition) (maybe permitted assistive devices).

Two are classified by IBSA Classifiers:

- B1 (Visually Impaired);
- B2/B3 Combined (Visually Impaired).

In addition, an open class is recognized:

- Open – any disability level above.

(Refer to the Classifier's Handbook for information on the details of Classification).

**AC 4.2.1.2**

Para-classification groups relate to the competitive Para-Archery Sports Classes.

W1 Open (open equipment as per rules Book 1 - AC 11.2.6 (ref. Book 3 - Article 21.4.4)).

- Men
- Women

Compound Open (open para-classification).

- Men
- Women

Recurve Open (open para-classification).

- Men
- Women Visually Impaired (VI)

There are two common VI archery divisions.

- VI 1 athletes wear a blindfold
- VI 2/3 who do not wear blindfolds

**AC 4.2.1.3**

Archery Canada believes that all individuals deserve respectful and inclusive environments for participation in our sport that values all individuals' gender identities and gender expressions. Archery Canada wants to ensure that all participants have access to programming and facilities in which they feel welcome, respected and safe. See Archery Canada's [Trans Inclusion Policy](#) for details.

**4.2.2.**

Separate events for Under 18 and Under 21 Women, Under 18 and Under 21 Men, 50+ Women and 50+ Men can be organised in the disciplines of Target and Field Archery. In Target Archery also for Under 15 Women and Under 15 Men.

**4.2.2.1.**

*At each competition an athlete can compete in one class only. This applies to all classes for which the athlete is eligible.*

**AC 4.2.2**

In addition, in Canada, separate events for all World Archery classes and also for U10, U13, U15, 50+, Women and Men can be organized in the disciplines of Target, Field and 3D Archery; and 60+ in the discipline of Canadian 3D.

**4.2.3.**

An athlete may participate in a Under 18 Class in tournaments when the competition takes place up to and in the year of the athlete's 17th birthday.

**4.2.4.**

An athlete may participate in a Under 21 Class in tournaments when the competition takes place up to and in the year of the athlete's 20th birthday.

**4.2.5.**

An athlete may participate in a 50+ Class in tournaments when the competition takes place in the year of the athlete's 50th birthday and thereafter.

**4.2.6**

An athlete may participate in an Under 15 Class in tournaments when the competition takes place up to and in the year of the athlete's 14th birthday.

**AC 4.2.6.**

An athlete may participate in a U10 Class in tournaments when the competition takes place up to and in the year of his 9th birthday.

**AC 4.2.7.**

An athlete may participate in a U13 Class in tournaments when the competition takes place up to and in the year of his 12th birthday.

**AC 4.2.8.**

An athlete may participate in a U15 Class in tournaments when the competition takes place up to and in the year of his 14th birthday.

**AC 4.2.9.**

An athlete may participate in a 60+ Class in tournaments when the competition takes place in the year of his 60th birthday and thereafter.

**4.3. DIVISIONS****4.3.1.**

Athletes using different types of bows are grouped in separate divisions and compete in separate events. World Archery recognises the following divisions:

**4.3.2.**

For Target Archery (see [Book 3, Target Archery](#)):

- Recurve Division;
- Compound Division;
- Barebow Division;
- Standard Bow Division (for Standard Round only).

**4.3.3.**

For Field Archery (see [Book 4, Field and 3D Archery](#)):

For championships:

- Recurve Division;
- Compound Division;
- Barebow Division.

**4.3.4.**

For Clout Archery (see [Book 5, 32.4. The Clout Round](#)):

- Recurve Division;
- Compound Division.

**4.3.5.**

For Flight Archery (see [Book 5, 32.5. Flight Shooting](#)):

- Target Recurve Bow;
- Conventional Flight Bow;
- American Longbow;
- English Longbow;
- Compound Flight Bow;
- Compound Target Bow;
- Foot Bow.

**4.3.6.**

For Para-Archery (see [Book 3, Chapter 21 - Para-Archery](#)):

- Recurve Division;
- Compound Division.

**4.3.7.**

For 3D Archery (see [Book 4, Field and 3D Archery](#)):

- Compound Division;
- Barebow Division;
- Longbow Division;
- [Instinctive](#) <sup>(WA Traditional)</sup> Division.

**4.3.8.**

Athletes may compete in different divisions of the same tournament but under no circumstances may the programme of the tournament be modified or be held up to accommodate that athlete.

**AC 4.3. AC Divisions**

Archery Canada recognizes the following divisions:

**AC 4.3.2**

for Target Archery:

- |                              |                                    |
|------------------------------|------------------------------------|
| • Recurve Division           | • Unlimited Division <sup>†</sup>  |
| • Compound Division          | • Fixed Pins Division <sup>†</sup> |
| • Barebow Division           | • Hunter Division <sup>†</sup>     |
| • Para Archery W1 Division   |                                    |
| • Para Archery Open Division |                                    |

<sup>†</sup> - Recognize for Indoor Target Archery only.

**AC 4.3.3**

for Field Archery:

- |  |                       |
|--|-----------------------|
| • Recurve Division   | • Unlimited Division  |
| • Compound Division  | • Fixed Pins Division |
| • Barebow Division   | • Hunter Division     |
| • Longbow Division   |                       |
| • <a href="#">Instinctive</a> <sup>(WA Traditional)</sup> Division |                       |

**AC 4.3.7**

for Canadian 3D Archery:

- Barebow Division
- Traditional Division
- Longbow Division
- Instinctive <sup>(WA Traditional)</sup> Division
- Unlimited Division
- Fixed Pins Division
- Hunter Division
- Known

**4.4. CATEGORIES**

The combination of a class and a division is defined as a ‘Category’ as follows:

<b>Recurve</b>			
Recurve Women	RW	Recurve Men	RM
Recurve Under 21 Women	RU21W	Recurve Under 21 Men	RU21M
Recurve 50+ Women	R50W	Recurve 50+ Men	R50M
Recurve Under 18 Women	RU18W	Recurve Under 18 Men	RU18M
Recurve Under 15 Women	RU15W	Recurve Under 15 Men	RU15M
<b>Compound</b>			
Compound Women	CW	Compound Men	CM
Compound Under 21 Women	CU21W	Compound Under 21 Men	CU21M
Compound 50+ Women	C50W	Compound 50+ Men	C50M
Compound Under 18 Women	CU18W	Compound Under 18 Men	CU18M
Compound U15 Women	CU15W	Compound Under 15 Men	CU15M
<b>Para Recurve</b>			
Recurve Women Open	RWO	Recurve Men Open	RMO
<b>Para Compound</b>			
Compound Women Open	CWO	Compound Men Open	CMO
<b>W1 Open</b>			
Women W1 Open (Rec/Comp)	WW1	Men W1 Open (Rec/Comp)	MW1
<b>Visually Impaired</b>			
Visually Impaired 1	VI1	Visually Impaired 2 / 3	VI2/3
<b>Barebow</b>			
Barebow Women	BW	Barebow Men	BM
Barebow Under 21 Women	BU21W	Barebow Under 21 Men	BU21M
Barebow Under 18 Women	BU18W	Barebow Under 18 Men	BU18M
Barebow Under 15 Women	BU15W	Barebow Under 15 Men	BU18M
<b>Longbow and Instinctive <sup>(WA Traditional)</sup> Bow</b>			
Longbow Women	LW	Longbow Men	LM
Instinctive* Women	IW	Instinctive* Men	IM

\* - Instinctive <sup>(WA Traditional)</sup> Division

## AC 4.4. CATEGORIES (CANADA)

In addition, Archery Canada recognizes other categories:

<b>Recurve</b>			
Recurve Women	RW	Recurve Men	RM
Recurve Under 21 Women	RU21W	Recurve Under 21 Men	RU21M
Recurve 50+ Women	R50W	Recurve 50+ Men	R50M
Recurve Under 18 Women	RU18W	Recurve Under 18 Men	RU18M
Recurve Under 15 Women	RU15W	Recurve Under 15 Men	RU15M
Recurve Under 13 Women	RU13W	Recurve Under 13 Men	RU13M
Recurve Under 10 Women	RU10W	Recurve Under 10 Men	RU10M
<b>Compound</b>			
Compound Women	CW	Compound Men	CM
Compound Under 21 Women	CU21W	Compound Under 21 Men	CU21M
Compound 50+ Women	C50W	Compound 50+ Men	C50M
Compound Under 18 Women	CU18W	Compound Under 18 Men	CU18M
Compound Under 15 Women	CU15W	Compound Under 15 Men	CU15M
Compound Under 13 Women	CU13W	Compound Under 13 Men	CU13M
Compound Under 10 Women	CU10W	Compound Under 10 Men	CU10M
Unlimited Women	UW	Unlimited Men	UM
Unlimited 50+ Women	U50W	Unlimited 50+ Men	U50M
Unlimited 60+ Women	U60W	Unlimited 60+ Men	U60M
Unlimited Under 18 Women	UU18W	Unlimited Under 18 Men	UU18M
Fixed Pins Women	FPW	Fixed Pins Men	FPM
Hunter Women	HW	Hunter Men	HM
Known Women	KW	Known Men	KM
Known Under 18 Women	KU18W	Known Under 18 Men	KU18M
Known Under 15 Women	KU15W	Known Under 15 Men	KU15M
Known Under 13 Women	KU13W	Known Under 13 Men	KU13M
<b>Barebow, Longbow, Instinctive <sup>(WA Traditional)</sup> and Traditional</b>			
Barebow Women	BW	Barebow Men	BM
Barebow 50+ Women	B50W	Barebow 50+ Men	B50M
Barebow Under 21 Women	BU21W	Barebow Under 21 Men	BU21M
Barebow Under 18 Women	BU18W	Barebow Under 18 Men	BU18M
Barebow Under 15 Women	BU15W	Barebow Under 15 Men	BU15M
Barebow Under 13 Women	BU13W	Barebow Under 13 Men	BU13M
Longbow Women	LW	Longbow Men	LM
Instinctive* Women	I*W	Instinctive* Men	I*M
Traditional 50+ Women	T50W	Traditional 50+ Men	T50M
Traditional Under 21 Women	TU21W	Traditional Under 21 Men	TU21M
Traditional Under 18 Women	TU18W	Traditional Under 18 Men	TU18M
Traditional Under 15 Women	TU15W	Traditional Under 15 Men	TU15M
Traditional Under 13 Women	TU13W	Traditional Under 13 Men	TU13M

\* - Instinctive <sup>(WA Traditional)</sup> Division

## 4.5. ROUNDS

### 4.5.1. OUTDOOR ARCHERY ROUNDS

#### 4.5.1.1.

Olympic Games and Paralympic Games

- In the Olympic Games only the Recurve Division may compete.
- In the Paralympic Games the Recurve Open Division, the Compound Open Division and the W1 division may compete in individuals women, individuals men, and in mixed teams.

#### 4.5.1.2.

The Elimination and Final Rounds consist of:

- The Elimination Round, in which the top 104 athletes (mandatory for World Archery Championships) are seeded according to their positions in the Qualifying Round (see [Appendix 3 - Match Play Charts](#)). They shoot a series of matches in groups, each match consisting of the best of five sets of three arrows for recurve and barebow, and five ends of three arrows for compound and W1;

- The Finals Round, in which the eight athletes remaining from the Elimination round shoot individual matches, each match consisting of the best of five sets of three arrows for recurve and barebow, and five ends of three arrows for compound and W1, culminating in the gold Medal match. At World Archery Championships the matches shall be shot one after the other. The athletes shall shoot alternately one arrow at a time.
- The Team Elimination Round, in which the top 24 teams (16 in the Olympic Games) of three athletes seeded according to their positions as determined by their total score in the Qualification Round (see [Match Play Chart 5](#) shoot simultaneously a series of matches, each match for recurve and barebow consisting of the best of four sets of six arrows (two per athlete) and for compound consisting of four ends of six arrows (two per athlete) in cumulative score;
- In Para-Archery, the Doubles Elimination Round in which the top 24 teams of two athletes seeded according to their positions as determined by their total score in the Qualification Round (see [Appendix 3-Match Play Charts, Match Play Chart 5 \(24 teams, byes are permitted\)](#)) shoot simultaneously a series of matches, each match for recurve open consisting of the best of four sets of four arrows (two per athlete) and for compound open and W1 consisting of four ends of four arrows (two per athlete) in cumulative score;
- The Team Finals Round, in which the four teams qualifying from the Elimination Round shoot a series of matches, each match for recurve and barebow consisting of the best of four sets of six arrows (two per athlete) and for compound consisting of four ends of six arrows (two per athlete) in cumulative score culminating in the Team Gold Medal match. In the Olympic Games, the Medal matches of the World Archery Championships and Archery World Cup Events, the teams shoot alternately in three arrow segments. For other events alternating shooting is optional. The timing is started and stopped when the athlete crosses the 1m line;
- In Para-Archery, the Doubles Finals Round, in which the four doubles qualifying from the Elimination Round shoot a series of matches, each match for recurve open consisting of the best of four sets of four arrows (two per athlete) and for Compound Open and W1 consisting of four ends of four arrows (two per athlete) in cumulative score culminating in the Doubles Gold Medal match. In the Medal matches of the World Archery Championships, the doubles shoot alternately in two arrow segments. For other events alternating shooting is optional. For more information on W1, please see [21.4.3.](#);
- The Mixed Team Round in which the top 24 teams (16 in the Olympic Games) composed of the top ranked man and the top ranked woman from the same Member Association are seeded according to their positions as determined by their total score in the Qualification Round (see [Appendix 3-Match Play Charts, Match Play Chart 5 \(24 teams, byes are permitted\)](#)), shoot simultaneously a series of matches, each match for recurve and barebow consisting of the best of four sets of four arrows (two per athlete) and for compound and W1 consisting of four ends of four arrows (two per athlete) in cumulative score;
- The format may be amended to fit special stadiums and locations that are very attractive for archery. It is necessary to notify Member Associations of such an amendment at least one year in advance of the event;
- For Recurve the round will be called the Olympic Round and shall be shot at 70m (60m for Under 18 and 50+) on 122cm target faces, whereas for compound it will be called the Compound Match Round and shall be shot at 50m on an 80cm six ring target face. For Barebow it will be called the Barebow Match Round and shall be shot at 50m on an 122cm target face. For W1, please see [Article 21.4.3. in Book 3](#);
- A team shall consist of the highest ranked three (or two if a Mixed Team or Doubles in Para-Archery) athletes from the Qualification Round unless the Team Manager notifies the official approved result verifier or the Chairman of Judges in writing at least fifteen minutes before the start of official practice of that round of competition of a substitution of another athlete who competed in the Qualification



Round. A violation of the foregoing will result in disqualification of the team. In case of substitution medals shall only be awarded to the athletes that shot the Team/Mixed Team/Doubles round, not the qualification round.

#### 4.5.1.3.

The 50m Round for Compound consists of 72 arrows on the 80cm target face.

#### 4.5.1.4.

The 60m Round (for Recurve) for Under 18 and 50+ consists of 72 arrows shot at 60m on the 122cm target face.

#### 4.5.1.5.

The 70m Round (for Recurve) consists of 72 arrows shot at 70m on the 122cm target face.

#### 4.5.1.6.

The Visually Impaired Round is defined in [Chapter 21 - Para-Archery, Book3](#).

#### 4.5.1.7.

The Barebow 50m Round consists of 72 arrows shot at 50m on the 122cm target face.

#### 4.5.1.8

The 40m Round for Recurve U-15 consists of 72 arrows shot at 40 meters on the 122cm target face.

#### 4.5.1.9

The 40m Round for Compound U-15 consists of 72 arrows shot at 40 meters on the 80cm target face.

#### 4.5.1.10

The 30m Round for Barebow U-15 consists of 72 arrows shot at 30 meters on the 122cm target face.

### 4.5.2. INDOOR ARCHERY ROUNDS

#### 4.5.2.1.

The 18m Round consists of 60 arrows on the 40cm target face or the 40cm triple face.

#### 4.5.2.2.

The Match Round is shot on the 40cm triple face at 18m and consists of:

##### 4.5.2.2.1.

- The Recurve Elimination Round, in which 32 athletes are seeded according to their positions in the Qualification Round (see [Match Play Chart 3 \(32 athletes, byes are permitted\)](#)). They shoot a series of matches in groups, each match consisting of the best of five sets of three arrows;
- The Recurve Finals Round, in which the eight athletes qualifying from the Elimination Round shoot a series of individual matches, each match consisting of the best of five sets of three arrows, culminating in the Gold Medal match. The athletes shall shoot alternately one arrow at a time;
- The Recurve Team Elimination Round, in which the top 16 teams of three athletes seeded according to their positions as determined by their total scores in the Qualification Round (see [Match Play Chart 4 \(16 athletes / teams, byes are permitted\)](#)), shoot simultaneously a series of matches, each Match consisting of the best of four sets of six arrows (two per athlete);
- The Recurve Team Finals Round, in which the four teams remaining from the Elimination Round shoot a series of individual matches, each Match consisting of the best of four sets of six arrows (two per athlete), culminating in the Team Gold Medal match.

##### 4.5.2.2.2.

- The Compound Elimination Round, in which 32 athletes are seeded according to their positions in the Qualification Round (see [Match Play Chart 3 \(32 athletes, byes are permitted\)](#)). They shoot a series of matches in groups, each match consisting of five ends with cumulative scoring.

- The Compound Finals Round, in which the eight athletes qualifying from the Elimination Round shoot a series of individual matches, each match consisting of five ends with cumulative scoring, culminating in the Gold Medal match. The athletes shall shoot alternately one arrow at a time;
- The Compound Team Elimination Round, in which the top 16 teams of three athletes seeded according to their positions as determined by their total scores in the Qualification Round (see *Match Play Chart 4 (16 athletes / teams, byes are permitted)*), shoot simultaneously a series of matches, each match consisting of four ends of six arrows (two per athlete);
- The Compound Team Finals Round, in which the four teams remaining from the Elimination Round shoot a series of individual matches, each match consisting of four ends of six arrows (two per athlete), culminating in the Team Gold Medal match.

#### 4.5.2.2.3.

- The Barebow Elimination Round, in which 32 athletes are seeded according to their positions in the Qualification Round (see [Appendix 3-Match Play Charts](#), [Match Play Chart 3 \(32 athletes, byes are permitted\)](#)). They shoot a series of matches in groups, each match consisting of the best of five sets of three arrows;
- The Barebow Finals Round, in which the eight athletes qualifying from the Elimination Round shoot a series of individual matches, each match consisting of the best of five sets of three arrows, culminating in the Gold Medal match. The athletes shall shoot alternately one arrow at a time;
- The Barebow Team Elimination Round, in which the top 16 teams of three athletes seeded according to their positions as determined by their total scores in the Qualification Round (see [Appendix 3-Match Play Charts](#), [Match Play Chart 4 \(16 athletes / teams, byes are permitted\)](#)), shoot simultaneously a series of matches, each Match consisting of the best of four sets of six arrows (two per athlete);
- The Barebow Team Finals Round, in which the four teams remaining from the Elimination Round shoot a series of individual matches, each Match consisting of the best of four sets of six arrows (two per athlete), culminating in the Team Gold Medal match.

#### 4.5.2.3.

The Visually Impaired Round is defined in [Article 21.12, Book 3](#). Visually Impaired Athletes.

#### 4.5.2.4

Indoor Rounds can be shot in outdoor conditions as well.

### 4.5.3. FIELD ARCHERY ROUNDS

#### 4.5.3.1.

The Field Round consists of 24 targets. Three arrows are shot per target. These targets shall be laid out in a course considering the challenges in aiming and shooting as the tradition of the discipline requires. The distances for target butts are set out in [Article 8.1.1.9. Unit for Unmarked Course](#) and [Article 8.1.1.10. Unit for Marked Course](#). The course may be all marked or all unmarked or a combination of marked and unmarked distances. There may be any number of walk-ups or fan targets.

##### 4.5.3.1.1.

*A round may use the same course twice, except at World Championships.*

#### 4.5.3.2.

The Arrowhead Round consists of 24 or 48 targets which is two complete Field Rounds. The distances are set out in [Article 8.1.1.9. Unit for Unmarked Course](#) and [Article 8.1.1.10. Unit for Marked Course](#). The rounds may be shot on marked, unmarked or any combination of marked and unmarked targets.

#### 4.5.3.3.

The World Archery Field Championship Round in which there are no walk-up or fan targets, consists of:

**4.5.3.3.1.**

The Qualification Round, two Field Rounds each of 24 targets, one unmarked course to be shot on the first day of competition and one marked to be shot on the second day of competition;

**4.5.3.3.2.**

The Elimination Round consists of a head to head system involving the top 16 athletes from the qualification round.

**4.5.3.3.3.**

The elimination round will be based on a match play chart with 16 athletes. (see Appendix 3 Matchplay charts [Match Play Chart 4 \(16 athletes / teams, byes are permitted\)](#))

**4.5.3.3.4.**

At the conclusion of each round of matches, the division will rotate to a different elimination course.

**4.5.3.3.5.**

Elimination matches will consist of 6 targets. All target faces should be available. Distances will be marked. Athletes will shoot simultaneously.

- In the elimination, if the athletes are in a group where 2 matches shooting (4 athletes):
  - The match with the higher ranked athlete will always shoot first;
  - If athletes are from the same division but of a different age class, then the oldest age class will always shoot first.

**4.5.3.3.6.**

If there are fewer than 16 athletes, all will progress to the elimination.

**4.5.3.3.7.**

The Finals Rounds in which the four top athletes shoot two matches (the semi-finals and the medal finals) consisting of four marked targets each, three arrows per target (see [Article 8.1.1.2.](#))

**4.5.3.3.7.1.**

*In the semi-finals, if the athletes shoot in a group of four, the pair with the highest ranking athlete shall shoot first, and the other pair shall shoot as the second pair at all targets. In the medal finals, the athletes competing in the Bronze Medal match shall shoot first at all targets, followed by the Gold Medal match.*

**4.5.3.3.7.2.**

*In the Finals Round the higher ranked athlete shall shoot from the left shooting position.*

**4.5.3.3.8.**

The top eight teams will shoot quarter final matches of four targets.

**4.5.3.3.9.**

Targets will be laid to challenge the team, taking in to account the landscape available. At the first target the higher ranked team decides who shall start shooting. Thereafter, the team with the lower cumulative score will shoot first at the following target and, if the teams are tied, then the team which started the match will shoot first. Teams will be positioned left/right target according to the printed scorecard;

**4.5.3.3.9.1.**

*They are seeded according to the positions as determined by the total scores (the three top scores) in the Qualification Round. The composition of the team shall be determined by the Team Manager. Each athlete shoots one arrow per target from the peg of th athlete's division (see match play). The winners of each match proceed to the Team Finals Round.*

**4.5.3.3.10.**

The Team Finals Rounds consist of the four qualifying teams (semi-finals) in each class, consisting of one athlete from each division.

- At the first target the higher ranked team decides who shall start shooting. Thereafter, the team with the lower cumulative score will shoot first at the following target and, if the teams are tied, then the team which started the match will shoot first;
- Teams will be positioned left/right target according to the printed scorecard;

**4.5.3.3.10.1.**

*Each athlete shoots one arrow per target from the peg of the athlete's division. The winning teams move to the Gold Medal match and the other teams move to the Bronze Medal match (Medal Finals). Both Medal matches are shot on an additional four marked targets (see individual finals for shooting procedures).*

**4.5.3.3.11.**

The Field Mixed Team Elimination Round and Final Round:

**4.5.3.3.11.1.**

A Mixed team is a male and female athlete from one division.

**4.5.3.3.11.2.**

In the Field Mixed team match each athlete shoots 2 arrows.

**4.5.3.3.11.3.**

Teams are seeded according to the positions as determined by the total scores (the top scores) in the Qualification Round. The composition of the team shall be determined by the Team Manager.

**4.5.3.3.11.4.**

The Mixed Team Elimination Round consists of the top eight teams shooting quarter final matches over a 4 target marked course.

**4.5.3.3.11.5**

The Mixed Team Finals Round consist of the four qualifying teams (semi-finals) in each class.

**4.5.3.3.11.5.1**

Both medal matches are shot on an additional four targets.

**4.5.3.4.**

Finals Round

**4.5.3.4.1.**

In the Finals Round each class and division shall form a group that shall start in this order:

- Barebow Women;
- Barebow Men;
- Recurve Women;
- Recurve Men;
- Compound Women;
- Compound Men.

**4.5.3.4.2.**

The organisers decide whether the Finals Round are shot as one continuous round or whether there shall be a break between the semi-finals and the medal finals. The reorganisation of the groups shall take place after the fourth target. In case of a tie in the semi-finals, the tie should be decided on the fourth target before the reorganisation of the groups takes place. The organisers may allow the different categories to shoot on separate courses to speed up the competition.

**4.5.3.4.3.**

Team finals courses will be different targets to those that are planned for the individual event.

#### 4.5.4. SKI-ARCHERY

##### 4.5.4.1.

Ski-Archery combines cross-country skiing and archery (see [Book 5, Chapter 33 - Ski-Archery](#)).

#### 4.5.5. FLIGHT

##### 4.5.5.1.

See [Book 5, 32.5. Flight Shooting](#).

#### 4.5.6. 3D ROUNDS

##### 4.5.6.1.

The 3D Round consists of 24 unmarked targets. Two arrows are shot per peg. These targets shall be laid out in a course considering the challenges in aiming and shooting as the tradition of the discipline requires. The distances for targets are set out in [Article 9.1.1.7.](#).

##### 4.5.6.2.

The 3D World Archery Championship Round consists of a Qualification Round followed by an Elimination Round and the Finals Rounds for Individuals and the Elimination Round and the Finals Round for Teams.

##### 4.5.6.2.1.

The Qualification Round consists of two 3D rounds of 24 unmarked targets.

##### 4.5.6.2.2.

The Elimination Round consists of a head to head system involving the top 16 athletes from the qualification round.

##### 4.5.6.2.3.

The elimination round will be based on a match play chart with 16 athletes. (see Appendix 3 Matchplay charts [Match Play Chart 4 \(16 athletes / teams, byes are permitted\)](#))

##### 4.5.6.2.3.1.

At the conclusion of each round of matches, the division will rotate to a different elimination course.

##### 4.5.6.2.4.

Elimination matches will consist of 6 targets. Distances will be unmarked. Athletes will shoot simultaneously.

- In the elimination, if the athletes are in a group where 2 matches from the same category are shooting (4 athletes) at the same targets, the match with the higher ranked athlete will always shoot first.

##### 4.5.6.2.5.

If there are fewer than 16 athletes all will progress to the elimination.

##### 4.5.6.2.6.

The Finals Rounds in which the top four athletes per category qualifying from the Elimination Round shall shoot two matches (the semi-finals and the medal finals) consisting of four targets each.

##### 4.5.6.2.6.1.

In the semi-finals, if the athletes shoot in a group of four, the pair with the highest ranking athlete shall shoot first, and the other pair shall shoot as the second pair at all targets. In the medal finals, the athletes competing in the Bronze Medal match shall shoot first at all targets, followed by the Gold Medal match.

##### 4.5.6.2.6.2.

In the Finals Round, the highest ranked athlete shall shoot from the left.

**4.5.6.2.7.**

The Team Elimination Round (quarter-finals) consists of the top eight teams in each class qualifying from the two Qualification Rounds shooting four targets each: A team shall be made up by one Compound, one Longbow, one **Instinctive** (WA Traditional) and one Barebow athlete. The team ranking shall be based on the best athlete's results for each category after the second Qualification Round.;

**4.5.6.2.7.1.**

The teams are seeded according to the team ranking as established on the basis of the individual ranking for each category after the second Qualification Round.

**4.5.6.2.7.2.**

At the first target the higher ranked team decides who shall start shooting. Thereafter, the team with the lower cumulative score will shoot first at the following target and, if the teams are tied, then the team which started the match will shoot first.

**4.5.6.2.7.3.**

Each athlete shoots one arrow per target from the peg of the athlete's division (see match play). The winners of each match proceed to the Team Finals Round.

**4.5.6.2.8.**

The Team Finals Rounds consist of the winning four teams from the Team Elimination Round. They shoot two matches of four targets each (semi-finals and Finals).

**4.5.6.2.8.1.**

First match: semi-finals: The higher placed team decides who shall start shooting at the first target. Thereafter, the team with the lower cumulative score will shoot first at the following target and, if the teams are tied, then the team which started the match will shoot first. Each athlete in the team shoots one arrow per target from the peg of the athlete's division; Second match: Medal Match: The winners move to the Gold Medal match and the others to the Bronze Medal match (Medal Finals). Both medal matches are shot on an additional four targets.

**4.5.6.2.8.2.**

Team finals courses will be different targets to those that are planned for the individual event.

**4.5.6.2.9.**

The 3D Mixed Team Elimination and final Round:

**4.5.6.2.9.1.**

A Mixed team is a male and female athlete from one division.

**4.5.6.2.9.2.**

In the 3D Mixed team match each archer athlete shoots 2 arrows.

**4.5.6.2.9.3.**

Teams are seeded according to the positions as determined by the total scores (the top scores) in the Qualification Round. The composition of the team shall be determined by the Team Manager.

**4.5.6.2.9.4.**

The Mixed teams will be positioned left/right target according to the printed scorecard.

**4.5.6.2.9.5**

The Mixed Team Elimination Round consists of the top eight teams shooting quarter final matches over a four target unmarked course.

**4.5.6.2.9.6**

The Mixed Team Finals Round consists of the four qualifying teams (semi-finals) shooting matches over a four target unmarked course.

**4.5.6.2.9.6.1**

Both medal matches are shot on an additional four targets

**4.5.6.3.**

Finals Rounds

**4.5.6.3.1.**

The athletes of the different categories shall start their Finals Rounds in the following order: Longbow women;

- Longbow women;
- Longbow men;
- **Instinctive** (WA Traditional) women;
- **Instinctive** (WA Traditional) men;
- Barebow women;
- Barebow men;
- Compound women;
- Compound men;
- Or all women shall shoot first followed by all men.

**AC 4.5 ROUNDS****AC 4.5.1**

Outdoor Archery Rounds

[AC Note: *Outdoor rounds must be held outdoors.*]

**AC 4.5.1.2**

In addition, the following distances are also recognized in Canada for the 1440 Round:

- 50, 40, 30, 20m for U15 Men and U15 Women
- 30, 25, 25, 20m for U13 Men and U13 Women
- Distances for U10 Men and U10 Women may vary

The 122cm target face is used for the two longer distances, and the 80cm target face (either full face or multiple centre set-up) is used for the two short distances.

**AC 4.5.1.4**

for clarity ..... bullet 7

The Olympic Rounds refer to the Elimination and Finals rounds for the Recurve Division shot on 122cm target faces at distances of:

- 70m for Senior and U21 classes
- 60 m for 50+ and U18 classes
- 40 m for U15 class
- 30 m for U13 class
- For Individual events, each match consists of the best of 5 sets of three arrows
- For the Team events, each match consists of the best of 4 sets of 6 arrows (2 per archer)
- For the Mixed Team events, each match consists of the best of 4 sets of 4 arrows (2 per archer)

The Compound Match Rounds refer to the Elimination and Finals rounds for COMPOUND Division shot on 80cm 6-ring target faces at distances of:

- 50m for Senior, 50+, U21, U18 classes.
- 40m for U15 classes shot on the 80cm full or 6-ring face.
- 30m for U13 class shot on the 80cm full face.

- For Individual events, each match consists of the 5 ends of three arrows
- For the Team events, each match consists of 4 ends of 6 arrows (2 per archer)
- For the Mixed Team events, each match consists of 4 ends of 4 arrows (2 per archer)

The Barebow Match rounds, refer to the Elimination and Finals rounds for the Barebow Division, shot on a 122cm target face at distances of:

- 50m for Senior, 50+, U21, U18 classes;
- 30m for the U15 classes;
- 30m for the U13 class.

For Individual Events, each match consists of the best of 5 sets of three arrows.

#### **AC 4.5.1.5 to AC 4.5.1.7**

The 720 Rounds are a composite of outdoor target rounds of 72 arrows that include:

- For Recurve - the WA 70m Round, the 60m Round and also distances for U15 and U13 athletes shot on the 122cm target face:
  - 70m for Senior and U21 Men and Women;
  - 60m for 50+ and U18 Men and Women;
  - 40m for U15 Men and Women;
  - 30m for U13 Men and Women.
- For Compound and Para-Archery Compound and Para-Archery W1 – the WA 50m Round at distances of:
  - 50m for 50+, Senior, U21, and U18 Men and Women shot on the 80cm 6-ring face;
  - 40m for U15 Men and Women shot on the 80cm full or 6-ring face;
  - 30m for U13 Men and Women shot on the full 80cm face.
- For Barebow, the WA 50m Round at distances of:
  - 50m for Senior, 50+, U21, U18 classes on the 122 cm face;
  - 30m for U15 classes on the 122 cm face;
  - 30m for U13 class on the 122 cm face.

#### **AC 4.5.1.14**

The Canadian 900 Round consists of 30 arrows on the 122 cm target face at each of the following distances:

- 55, 45, and 35m for 50+ Men, [Senior] Men, U21 Men, and U18 Men;
- 55, 45, and 35m; for 50+ Women, [Senior] Women, U21 Women, and U18 Women;
- 45, 35, and 25m for U15 Men and U15 Women;
- 30, 25, and 20m for U13 Men and U13 Women;
- Distances for U10 Men and U10 Women may vary.

#### **AC 4.5.1.15**

The Canadian 1200 Round consists of 30 arrows on the 122 cm target face at each of the following distances:

- 70, 60, 50, and 40m for 50+ Men, [Senior] Men, and U21 Men;
- 60, 50, 40, and 30m for 50+ Women, [Senior] Women, and U21 Women;
- 60, 50, 40, and 30m for U18 Men and U18 Women;
- 50, 40, 30, and 20m for U15 Men and U15 Women;
- 35, 30, 25, and 20m for U13 Men and U13 Women;
- Distances for U10 Men and U10 Women may vary.

#### **AC 4.5.1.16**

The Canadian Double Elimination Round (CDE) consists of head-to-head matches following the pairing chart posted on the Forms Page of the Archery Canada website. If seeding is done using a qualifying round, there is not necessarily a cut for entry into the Double Elimination Round, and byes may be given as necessary. Similar rules apply for the WA Olympic Round, WA Compound Match Round, and the WA Barebow Match Round (see [Article AC 4.5.1.4](#) and [Article 4.5.1.4](#))

#### **AC 4.5.1.17**

The T2S 900 Round consists of 30 arrows on the full 80 cm target face at each of the following distances

- 35m, 30m, and 25m Distances for U10 Men and U10 Women may vary.

The T2S 900 Round is a developmental club round not intended for championships.



**AC 4.5.2.9**

The Canadian 300 Round consists of 30 arrows shot at 18m on the 40cm target face or the 40cm triple face.

- NOTE: the Canadian 300 Round is the ONLY indoor round scored X - 10 - 9 .... - 1 on a target with both inner and outer 10-rings.

**AC 4.5.3 Field Archery Rounds (Canadian)**

Archery Canada follows the same Field Archery rules as World Archery with the additions below:

**AC 4.5.3.3.**

The Archery Canada Field Championship Round is a modified version of the World Archery Championship Round in which there are no walk-up or fan targets and consists of:

**AC 4.5.3.3.1.**

The Qualification Round:

- Two Field Rounds each of 12 targets:
  - One unmarked course;
  - One marked.
- To be shot on the same day of competition.

**AC 4.5.3.3.2.**

The Elimination Round consists of a head-to-head system involving the top 16 athletes from the qualification round.

**AC 4.5.3.3.3.**

The elimination round will be based on a match play chart with 16 athletes. (see [Appendix 3 Matchplay charts Match Play Chart 4 \(16 athletes/teams, byes are permitted\)](#)).

**AC 4.5.3.3.4.**

At the conclusion of each round of matches, the division will rotate to a different elimination course.

**AC 4.5.3.3.6.**

Elimination matches will consist of 6 targets. All target faces should be available. Distances will be marked. Athletes will shoot simultaneously.

- In the elimination, if 2 matches are in a group shooting at the same targets (4 athletes):
  - The match with the higher-ranked athlete will always shoot first;
  - If athletes are from the same division but of a different age class, then the oldest age class will always shoot first.

**AC 4.5.3.3.7.**

Where there are four (4) or fewer competitors, they will advance directly to the Semi-Finals/Finals with the athlete ranked 1 vs. the athlete ranked 4 and the athlete ranked 2 vs. the athlete ranked 3.

- These final matches can be run at the same time as the elimination matches to speed up the Finals.

**AC 4.5.3.3.8.**

The Finals Rounds in which the four top athletes shoot two matches (the semi-finals and the medal finals) consisting of:

- Four marked targets;
- One of each size target face, 20cm, 40cm, 60cm and 80cm;
- Three arrows per target;
- When possible, the Finals field will be set up in a location that safely allows spectators to view the finals, similar to the World Archery Field Archery finals.

**AC 4.5.3.3.8.1.**

In the semi-finals, if the athletes shoot in a group of four, the pair with the highest-ranking athlete shall shoot first, and the other pair shall shoot as the second pair at all targets. In the medal finals, the athletes competing in the Bronze Medal match shall shoot first at all targets, followed by the Gold Medal match.

**AC 4.5.3.3.8.2.**

In the Finals Round, the higher-ranked athlete shall shoot from the left shooting position.

**AC 4.5.3.4.**

Finals Round

**AC 4.5.3.4.1.**

In the Finals Round, each class and division shall form a group that shall start in this order:

- Barebow Women;
- Barebow Men;
- Recurve Women;
- Recurve Men;
- Compound Women;
- Compound Men.

**AC 4.5.3.4.2.**

The organisers decide whether the Finals Round is shot as one continuous round or whether there shall be a break between the semi-finals and the medal finals. The reorganisation of the groups shall take place after the fourth target. In case of a tie in the semi-finals, the tie should be decided on the fourth target before the reorganisation of the groups takes place. The organisers may allow the different categories to shoot on separate courses to speed up the competition.

**AC 4.5.3.5 to 4.5.3.7**

In addition, ... other Canadian categories shoot from each peg.

Yellow Peg	Blue Peg	Red Peg
all U13	Recurve U18	Recurve & Compound
all U15	Compound U18	U21, senior, 50+
Barebow U18	Barebow	Unlimited
Longbow	Instinctive*	Fixed Pins
		Hunter

\*- Instinctive (WA Traditional)

**AC 4.5.7.0 3D Rounds (Canadian)****AC 4.5.7.0.1**

The Canadian Outdoor 3D Round typically consists of an event for individual archers consisting of rounds on one, two or three outdoor courses with between 20 and 25 3-dimensional animal targets on each course.

**AC 4.5.7.0.2**

The Canadian Outdoor 3D Championship typically consists of:

**AC 4.5.7.0.2.1 3D Individual Event (2023 ver.)**

Individual Qualification Round consisting of:

- Three (3) courses of twenty (20) 3D targets;
- One arrow per target;
- Over two (2) days;
- In any category, U15 and above, with three (3) or more competitors, the top five (5) move on to the finals;
- For U13, medals will be determined based on the total of the Qualification round.

**AC 4.5.7.0.2.1.**

For ties regarding progress from the Qualifications round to the Finals round, there shall be shoot-offs to break the ties:

- A single arrow shoot-off for score;
- If the score is the same, the arrow closest to the centre shall resolve the tie, and if the distance is the same, successive single arrow shoot-offs until the tie is resolved;
- The time limit for a shoot-off shall be one minute;
- This shoot-off will take place in a central area after the qualification courses are complete.

**AC 4.5.7.0.2.2**

Individual Finals Round:

- For the individual finals round, scores will carry over from the Qualification round total of 60 targets;
- Finals will be five (5) targets at varying distances and sizes;

- The TD will choose the targets and distances that archers will shoot during finals.
- The Finals will be shot on a Finals field.
  - One arrow per target;
  - One (1) minute to shoot one arrow;
  - Archers will be assigned one of the five (5) targets to start;
  - Archers will shoot and score their first target;
  - Archers will then rotate to the next target to shoot and score;
  - This is repeated until all five (5) targets have been shot;
  - For the **Individual Finals Only**, an arrow shot inside the 11 scoring ring scores 14 points unless the arrow breaks the line of the 11 rings, in which case it will score 11 points.
- The highest three scores, Qualification plus Finals, after five targets, will be medalists;

#### AC 4.5.7.0.2.2.1

For ties for deciding the Medal placements in the Finals Round, there shall be shoot-offs to break the ties:

- A single arrow shoot-off for score;
- If the score is the same, the arrow closest to the centre shall resolve the tie, and if the distance is the same, successive single arrow shoot-offs until the tie is resolved;
- The time limit for a shoot-off shall be one minute;
- This shoot-off will take place on a new target.

#### AC 4.5.7.0.2.2.2

For categories with less than three (3) competitors, medals will be determined based on the total of the Qualification round.

#### AC 4.5.7.0.2.2.3 Equipment Failures

In the Individual Finals Round and all Mixed Team Rounds, no extra time shall be allowed for equipment failure or the treatment of unexpected medical problems. In the Team Event, other members of the team may shoot in the meantime.

#### AC 4.5.7.0.2.3 3D Mixed Team Event

The Mixed Team event is a separate event. The registration fee per team will be set before each Championship. Each team is registered in advance of the Championships:

- Provinces may designate a mixed team in the following Groups:

Group	Division / Class	Peg / Max. Yd.
Known	Known Senior and Hunter <sup>†</sup>	Orange / 50 yd.
Senior Compound	Senior Unlimited (all age classes)	Orange / 50 yd.
Youth Known	Known U18 and Known U15	White / 30 yd.
Un sighted	Traditional, Barebow, Instinctive <sup>(WA Traditional)</sup> and Longbow	White / 30 yd.

<sup>†</sup> - Hunter will shoot max. 50 yd. in the mixed team round

- A mixed team consists of one female and one male athlete of the same group.
- Following a date to be set by the LOC, all remaining team slots can be filled by individuals;
- A minimum of four (4) and a maximum of eight (8) teams in each of the four (4) Groups for a total of 32 teams.

#### AC 4.5.7.0.2.3.1 Mixed Team Ranking

Teams in each Mixed Team Group are ranked 1 through 8 based on the team members' total scores from the Individual Qualification Round.

#### AC 4.5.7.0.2.3.2 Mixed Team Elimination Round:

- Teams will be paired for eliminations:
  - 1 vs. 8, 3 vs. 6, 2 vs. 7, and 5 vs. 4 (see match play chart below);
- A round of five targets is shot on one of the three (3) Individual Qualification courses;
- A judge may be assigned to each set of teams, such that the competition will begin on targets 1, 6, 11, & 16 and will rotate with the archers to each subsequent target until all five (5) have been shot;
- Because of the limitation of time and the number of judges available:
  - Two Groups will shoot the same course and targets at the same time;

- Senior Known teams will shoot with the Senior Compound teams, and Youth Compound teams will shoot with the Unsighted teams;
- The Senior Compounds will shoot and score first, and Senior Know will shoot and score second at each of the five (5) targets;
- The Youth Compound will shoot and score first, and Unsighted will shoot and score second at each of the five (5) targets.
- The four winning teams will advance to the finals.

**Match Play Chart: 8 Teams (Byes are Permitted)**

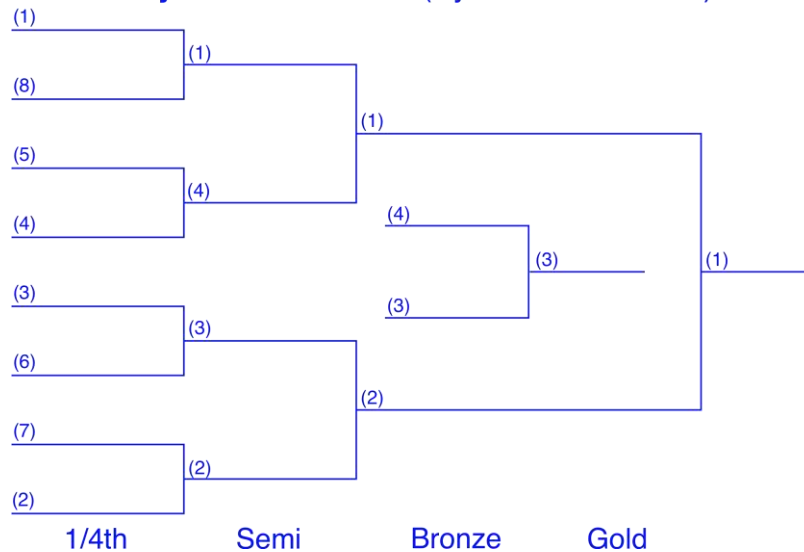

**AC 4.5.7.0.2.3.2.1**

Elimination Round Shooting:

- Each archer shoots one (1) arrow;
- The time limit for mixed teams is 90 seconds, [Book 4 Article 24.8](#);
- No shooting shall be allowed after the time limit has expired;
- If an athlete shoots an arrow after the Judge has stopped the shooting, the athlete or team shall lose the highest-scoring arrow at the target;
- Both teams shall start each end of their match with the athletes behind the peg;
- The first athlete may approach the peg when the judge has given the signal to start the match;
- Athletes will rotate after every arrow;
- Only one athlete from each team may be on the peg at any time;
- Both teams will shoot at the same peg at the same time.

**AC 4.5.7.0.2.3.2.2**

For ties regarding progress to the Finals or for deciding the Medal placements in the Finals Round, there shall be shoot-offs to break the ties ([Book 4 Article 25.3.3.3](#)):

- An end of two arrows (one by each athlete) shoot-off for score;
- Athletes in the team will shoot alternately;
- If the score is still tied, the team with the arrow closest to the centre shall win; and, if still tied, the second closest to the centre arrow shall determine the winner;
- The time limit shall be 90 seconds;
- This shoot-off will take place on the last target shot.

**AC 4.5.7.0.2.3.3.**

Finals Round:

- The finals will consist of semi-final, bronze and gold matches;
  - The winners of the semi-finals go to the gold medal match, and the loser to the bronze medal match.
- The final matches will be shot on the Finals field;
- Each match will be three (3) targets:
  - All three (3) targets will be shot before they are scored.
- The TD will choose the targets and distances that archers will shoot during finals;
- The matches will be shot as in the Elimination Round, AC 4.5.7.0.2.3.2.1.

**AC 4.5.7.0.2.3.4 Prize Purse**

<b>Team Event Prize Purse</b>	
<b>Senior Compound</b>	<b>Known</b>
100% of the Group's Registration Fees (GRF)	100% of the Group's Registration Fees (GRF)
1 <sup>st</sup> place - 5/8 <sup>th</sup> of the GRF	1 <sup>st</sup> place - 5/8 <sup>th</sup> of the GRF
2 <sup>nd</sup> place - 1/4 of the GRF	2 <sup>nd</sup> place - 1/4 of the GRF
3 <sup>rd</sup> Place - 1/8 <sup>th</sup> of the GRF	3 <sup>rd</sup> Place - 1/8 <sup>th</sup> of the GRF
<b>Youth Known</b>	<b>Un sighted</b>
100% of the Group's Registration Fees (GRF)	100% of the Group's Registration Fees (GRF)
1 <sup>st</sup> place - 5/8 <sup>th</sup> of the GRF	1 <sup>st</sup> place - 5/8 <sup>th</sup> of the GRF
2 <sup>nd</sup> place - 1/4 of the GRF	2 <sup>nd</sup> place - 1/4 of the GRF
3 <sup>rd</sup> Place - 1/8 <sup>th</sup> of the GRF	3 <sup>rd</sup> Place - 1/8 <sup>th</sup> of the GRF
<ul style="list-style-type: none"> <li>• The prize purse for each Group will be awarded based on the total registration fees for the Group.</li> <li>• A portion of no more than 4% of the overall registration fees will be withheld by the LOC for associated costs.</li> <li>• Where possible Contingencies from Archery Manufacturers may be used to augment the Purse.</li> <li>• Cash prizes are to be awarded at the time of the medals.</li> </ul>	

**AC 4.5.7.0.3**

The Canadian Indoor 3D Round typically consists of an event for individual archers consisting of rounds on one or two indoor ranges with between 20 and 25 3-dimensional animal targets on each range.

**AC 4.5.7.0.4**

The Canadian Indoor 3D Championship Round consists of an event for individual archers consisting of rounds on three or 4 indoor ranges with varying numbers of 3-dimensional animal targets, typically totalling 80 targets. This is usually followed by the 3D Grand Prix event.

[AC Note: *A single course may be used if target distances are altered between rounds.*]

**AC 4.5.7.0.5**

The Canadian 3D Grand Prix event consists of sequential matches in which the top 8 archers from qualification 3D rounds shoot elimination matches on 3D targets until only the winning archer remains.

**AC4.5.7.0.5.1**

Participating archers are grouped in categories according to the stake at which they shoot:

- Indoor 3D Nationals:
  - White Stake (Max 30):
    - ◆ U18 Traditional;
    - ◆ U21 Traditional;
    - ◆ 50+ Traditional;
    - ◆ Instinctive <sup>(WA Traditional)</sup>;
    - ◆ Longbow;
    - ◆ Barebow
    - ◆ U15 Know;
    - ◆ U13 Known.
  - Orange Stake (Max 50):
    - ◆ U18 Known;
    - ◆ Senior Known;
    - ◆ Hunter;
    - ◆ U18 Unlimited;

- ♦ 50+ Unlimited;
- ♦ 60+ Unlimited;
- ♦ Fixed Pins;
- ♦ Unlimited.

Men and Women shoot in separate categories.

#### **AC4.5.7.0.5.2**

The elimination within each category proceeds:

The male and female categories shall be run concurrently to save time for each division.

Targets are arranged at varying distances throughout the range such that several targets may be designated and shot from each stake. Any target may be designated for shots by a group, but in no case will targets farther than the maximum distance from a stake be designated.

The archers in each category will be divided into two groups according to their ranking position. The archers ranked 1, 3, 6 and 8 initially shoot as one group, and the archers ranked 2, 4, 5 and 7 shoot as another group. If there are four archers, they shoot as one group.

All the archers in each group shoot at the same designated target - not necessarily the same target or the same distance as used by the other group in the category. These targets must be different from the target/distance combinations previously shot by any of the archers in the category.

The shooting order in the groups shall be determined in the following manner:

- Two (2) groups of four (4) archers will be created for each shooting stake:
  - (1,3,6,8);
  - (2,4,5,7).
- The groups will be as follows for each shooting stake;
  1. (4 male) (4 male) (4 female) (4 female);
  2. (3 male) (3 male) (3 female) (3 female);
  3. (4 male) (4 female) \*\*\*Groups Combine\*\*\*;
  4. (3 male) (3 female);
  5. (2 male) (2 female);
- The order of shooting for each target shall start with the lowest-ranked archer and proceed to the highest-ranked. The order will not rotate.

If someone from the top eight (8) does not intend to participate in the Grand Prix, the Host Committee shall move down the results list to the next eligible archer until eight (8) archers are found. If they are unable to find eight (8) archers to participate, the first group of three (3) shall be the group containing the number one ranked archer entering the Grand Prix.

Arrows are scored after all shooters in the group have shot their arrows.

The furthest arrow from the centre of the 11 ring will be eliminated after each target and will be measured by the judges. Archers will not be allowed past the shooting line once the event starts, and judges will pull all the arrows.

Any archer missing the target is eliminated. If all archers miss a target, a new target will be selected by the DoS and all the archers will re-shoot the target, who missed the previous target.

The last remaining archer is the Grand Prix Winner for that category.

## **4.6. EVENTS AND TOURNAMENTS**

### **4.6.1.**

An event is a competition for which a separate list of results and separate set of prizes or titles can be given.

### **4.6.2.**

A tournament is an organised competition consisting of one or more events.

#### **4.6.2.1.**

*Where tournaments consist of events belonging to more than one discipline, as specified in [Article 4.1. Disciplines](#), the programme shall follow the order in which the disciplines are listed.*

## 4.7. WORLD ARCHERY EVENTS

### 4.7.1.

Only tournaments consisting of one or more of the following events can obtain official recognition from World Archery.

### 4.7.2.

In the discipline of Outdoor Archery:

- For the U18 Women, U18 Men, U21 Women, U21 Men, Women, Men, 50+ Women and 50+ Men classes:
  - The 1440 Round;
  - The 1440 Round for Teams;
  - The Double 1440 Round;
  - The Double 1440 Round for Teams;
  - The 70m Round (recurve only);
  - The Double 70m Round (recurve only);
  - The 60m Round for U18 and 50+ (recurve only);
  - The Double 60m Round for U18 and 50+ (recurve only);
  - The 70m Round for Teams (recurve only);
  - The 60m Round for U18 and 50+ Teams (recurve only);
  - The Olympic Round (recurve only);
  - The Olympic Round for U18 and 50+ (recurve only);
  - The Compound 50m Round (compound only);
  - The Compound Double 50m Round (compound only);
  - The Compound 50m Team Round (compound only);
  - The Compound Match Round (compound only);
  - The Barebow 50m Round (barebow only);
  - The Barebow Double 50m Round (barebow only);
  - The Barebow 50m Team Round (barebow only);
  - The Barebow Match Round (barebow only).

### 4.7.3.

In the discipline of Indoor Archery:

- For the Recurve, Barebow and Compound Divisions for U18 Women, U18 Men, U21 Women, U21 Men, Women, Men, 50+ Women and 50+ Men:
  - The 18m Round;
  - The 25m Round;
  - The Combined Round;
  - The Recurve Indoor Match Round;
  - The Compound Indoor Match Round;
  - The Barebow Indoor Match Round;
  - The Recurve Indoor Match Team Round;
  - The Compound Indoor Match Team Round;
  - The Barebow Indoor Match Team Round.

### 4.7.4.

In the discipline of Field Archery:

- For the Barebow, Recurve and Compound Divisions for U18 Women, U18 Men, U21 Women, U21 Men, Women, Men, 50+ Women and 50+ Men:
  - Field Round;
  - Arrowhead Round;
  - World Championship Round.

**4.7.5.**

In the discipline of Ski Archery (see [Chapter 33 - Ski-Archery, Book 5](#)).

**4.7.6.**

In the discipline of Clout Archery (see [32.4. The Clout Round, Book 5](#)).

**4.7.7.**

In the discipline of Flight Archery (see [32.5. Flight Shooting, Book 5](#)).

**4.7.8.**

In the discipline of 3D Archery (see [The correct reference will be inserted as soon as possible.](#)).

**4.7.9.**

In the discipline of Run-Archery (see [32.7. Run Archery, Book 5](#)).

**4.7.10.**

In the discipline of Para-Archery (see [Chapter 21 - Para-Archery, Book 3](#)).

**AC 4.7 ARCHERY CANADA EVENTS****AC 4.7.0**

Tournaments consisting of one or more of the following events, as described in detail in the relevant article on the shooting rules, can obtain official recognition by Archery Canada. (see [Article AC 5.4.2](#) re recognition of other events.)

**AC 4.7.0.1**

In the discipline of Outdoor Target Archery:

For all Archery Canada divisions as specified for Target Archery [Article AC 4.3.2](#):

- The 1440 Round;
- The 720 Rounds, which include:
  - The 70 meters Round (for Recurve);
  - The 60 meters Round (for Recurve; includes U15 and U13 distances);
  - The Compound 50m Round (for Compound, Unlimited and Fixed Pins Divisions; includes U15 and U13 distances);
  - The Barebow 50m round (Includes U15 and U13 distances).
- Olympic Round (for Recurve);
- Olympic Team Round (for Recurve);
- Olympic Mixed Team Round (for Recurve);
- Compound Match Round;
- Compound Match Round for Teams;
- Compound Match Round for Mixed Teams;
- The Barebow Match Round;
- Canadian 1200 Round;
- Canadian 900 Round;
- Canadian Double Elimination Round.

**AC 4.7.0.2**

In the discipline of Indoor Target Archery:

For all Archery Canada divisions as specified for Target Archery in [Article AC 4.3.2](#):

- The 25 metre Round;
- The 18 metre Round;
- The Combined Indoor Round;
- The Indoor Recurve Match Round;
- The Indoor Recurve Team Round;
- The Indoor Compound Match Round;
- The Indoor Compound Team Round;



- The Canadian 300 Round.

**AC 4.7.0.3**

In the discipline of Field Archery:

For all Archery Canada divisions as specified for Field Archery in [Article AC 4.3.3](#):

- Field Round (24 target – not short course);
- IFAA Field Round.

**AC 4.7.0.4**

In the discipline of 3D Archery:

For the Archery Canada divisions specified for 3D Archery in [Article AC 4.3.7](#):

- Outdoor 3D Round;
- Outdoor 3D Championship Round;
- Indoor 3D Round;
- Indoor 3D Championship Round.

**4.8. OFFICIAL RECOGNITION OF TOURNAMENTS****4.8.1.**

World Archery gives official recognition to tournaments for one or more of the following purposes:

- Competition for World titles (World Championships);
- Competition for Olympic titles (Olympic Archery Tournament);
- Competition for Paralympic titles (Paralympic Archery Tournament);
- Competition for World Ranking;
- Competition for Performance Awards and World Records;
- Competition for the gaining of Olympic and Paralympic qualification.

**4.8.2.**

Requirements for the official recognition of tournaments.

**4.8.2.1.**

*In order to obtain official recognition, tournaments shall conform to the standards of organisation set out in the appropriate articles in respect of:*

- *Registration;*
- *Announcement or invitations;*
- *Participation of athletes from other Member Associations;*
- *Order of shooting (target/group list);*
- *Judging;*
- *Publication of results.*

**4.8.2.2.**

*Member Associations, wishing to obtain official recognition for a tournament shall announce it to the Secretary General seven days before the start of the competition including:*

- *The name and place of the tournament;*
- *The events it includes;*
- *Whether or not the tournament is open to teams or individual members of other Member Associations.*

**4.8.2.3.**

*Provide a Director of Shooting and Judges and, in the case of international tournaments, a Jury of Appeal of three members; all Judges shall be approved by their Member Association or by World Archery.*

**4.8.2.4.**

*Changes in the information requested under [Article 4.8.2.2](#). can only be accepted by the Secretary General if*

*announced at least seven days before the first day of shooting.*

## **AC 4.8 OFFICIAL RECOGNITION OF ARCHERY CANADA TOURNAMENTS**

### **AC 4.8.1**

Archery Canada gives official recognition to tournaments for the following purposes:

- Competition for Championship Titles;
- Competition for Performance Awards and Canadian Records;
- Competition for ranking and qualification and gaining position on Canadian Teams.

### **AC 4.8.3**

Requirements for the official recognition of tournaments by Archery Canada.

#### **AC 4.8.3.1**

Tournaments must be organized and officiated in accordance with the provisions of the Archery Canada Rulebook.

#### **AC 4.8.3.2**

An event must be registered with Archery Canada at least 7 days in advance of the tournament start date. An event is not considered registered until the registration fee for the event is received by Archery Canada.

#### **AC 4.8.3.3**

Organizers must be able to accommodate a minimum of three (3) athletes and up to at least ten (10) athletes

- If an event only has three (3) participants, if it is perceived that one or more of the participating athletes is unlikely to finish the event, the event should be cancelled immediately;
- During an event with only three (3) participants, if an athlete must withdraw before the end of the event due to unforeseen circumstances, resulting in fewer than 3 athletes participating, then:
  - The judge or DoS must explain, in writing, the circumstances in a tournament report;
  - The score of all participants must be reported, and all scorecards held or submitted, following regular guidelines.

#### **AC INTERPRETATION: SMALL EVENT PARTICIPATIONS NUMBERS**

#### **AC 4.8.3.4**

The event must be officiated by a certified Provincial (or higher) Judge.

##### **4.8.3.4.1**

The name of the Judge, along with a Judge Tournament Report, must be provided to Archery Canada when the results are submitted to Archery Canada.

#### **AC 4.8.3.5**

A round held in Canada that is registered with World Archery is automatically registered with Archery Canada. [AC Note: *some rounds recognized in Canada, such as the Canadian 300 Round, are Archery Canada rounds that cannot be registered, and records are not kept for this round.*]

#### **AC 4.8.3.6**

The results of events registered with Archery Canada will be recognized only if at least three athletes participate.

#### **AC 4.8.3.7**

Where the organizers of an event wish to allow flexibility in how athletes may register for sanctioned events by scheduling the shooting of long and short distances over two or more days, the following principle will apply:

##### **AC 4.8.3.7.1**

The number of events to be registered for a tournament is equal to the maximum number of event scores it is possible for a single athlete to attain in the event, given that no distance score may be counted in more than one event.

## CHAPTER 5 - TITLES AND RECORDS

### 5.1. WORLD CHAMPIONSHIP TITLES

#### 5.1.1.

World Archery Championships for the Recurve and Compound Divisions:

- U18 Woman World Champion;
- U18 Man World Champion;
- U18 Women's Team World Champion;
- U18 Men's Team World Champion.
- U18 Mixed Team World Champion;
- U21 Woman World Champion;
- U21 Man World Champion;
- U21 Women's Team World Champion;
- U21 Men's Team World Champion;
- U21 Mixed Team World Champion;
- Woman World Champion;
- Man World Champion;
- Women's Team World Champion;
- Men's Team World Champion;
- Mixed Team World Champion;
- 50+ Woman World Champion;
- 50+ Man World Champion.

#### 5.1.2.

World Archery Indoor Championships for the Recurve and Compound Divisions (optional for 50+ World Championships):

- 50+ Woman World Champion;
- 50+ Man World Champion.

#### 5.1.3.

Field Archery World Championships for the Barebow, Recurve and Compound Divisions:

##### 5.1.3.1.

Individual Titles:

- U21 Woman World Champion;
- U21 Man World Champion;
- Woman World Champion;
- Man World Champion;
- 50+ Woman World Champion;
- 50+ Men World Champion.

##### 5.1.3.2.

Team Titles (one Barebow, one Recurve and one Compound):

- U21 Women's Team World Champion;
- U21 Men's Team World Champion;
- Women's Team World Champion;
- Men's Team World Champion.

Mixed Team Titles (one man, one woman for each category):

- Mixed Team World Champion;
- U21 Mixed Team World Champion.

#### 5.1.4.

Ski Archery (see [Chapter 33 - Ski-Archery, Book 5](#)).

#### 5.1.5.

3D Archery World Championships for the Compound, Longbow, Barebow and Traditional Bow Divisions:

- Woman World Champion;
- Man World Champion;
- Women's Team World Champion;
- Men's Team World Champion;
- Mixed Team World Champion.

#### 5.1.6.

Flight Archery (see [32.5. Flight Shooting, Book 5](#)):

- U21 Woman World Champion;
- U21 Man World Champion;
- Woman World Champion;
- Man World Champion.

#### 5.1.7.

Run-Archery (see [32.7. Run Archery, Book 5](#)).

#### 5.1.8.

Para-Archery (see [Chapter 21 - Para-Archery, Book 3](#)).

## AC 5.1 CANADIAN CHAMPIONSHIP TITLES

In the following, “XXX” denotes the category. (For example: “Recurve 50+ Men”).

### AC 5.1.1

Canadian Outdoor Target Championships titles will apply for each category available:

- Canadian Outdoor Target Champion - XXX

### AC 5.1.2

Canadian Regional Indoor Championships titles will apply for each category available:

- Canadian Indoor Champion - XXX;
- Canadian Indoor Champion Team.

### AC 5.1.3

Canadian Field Championships titles will apply for each category available:

- Canadian Field Champion - XXX

### AC 5.1.4

3D Archery

#### AC 5.1.4.1

Canadian 3D Outdoor Championships titles will apply for each category available:

- Canadian 3D Outdoor Individual Champion –XXX
- Canadian 3D Outdoor Mixed Team Champion – XXX.

#### AC 5.1.4.2

Canadian 3D Indoor Championships titles will apply for each category available:

- Canadian 3D Indoor Champion –XXX
- Canadian 3D Indoor Grand Prix Champion – XXX.

**AC 5.1.5**

Fred Usher Memorial Cup:

- Fred Usher Memorial Cup Champion Team.

**5.2. WORLD RECORDS - DEFINITION****5.2.1.**

A new record shall be established when a score is at least one point higher, or in Flight Archery, the distance shot is 1cm further, than an existing record.

**5.2.2.**

In case of a perfect score shot in Outdoor Archery a new record shall include the number of Inner 10s (X's) and shall require at least one more X than the existing record.

**AC 5.2 CANADIAN RECORDS - DEFINITION****AC 5.2.1**

A new record shall be established when a score is at least one point higher than an existing record.

**AC 5.2.1.1**

Should a Canadian Record be broken by two or more equal scores made on the same day, the athletes will be declared Joint Canadian Record holders.

**AC 5.2.1.2**

The name of any athlete who ties an existing record will be shown along with the name of the record holder.

**AC 5.2.2.**

Should more than one archer claim a perfect score:

- In Outdoor Target Archery, a new record shall include the number of Inner 10s (X's) and shall require at least one more X than the existing record;
- In Indoor Target Archery (600/600), then
  - The first archer who claims the record will be declared the record holder; and
  - All the others (except if shot the same day) will be recognized and listed under the record holder.

**5.3. WORLD RECORDS****5.3.1.**

There shall be World Records

**5.3.1.1.**

*for Outdoor Archery for U18 Women, U18 Men, U21 Women, U21 Men, Women, Men, 50+ Women and 50+ Men in the Recurve, Barebow and Compound Divisions as applicable:*

- 1440 Round;
- 90m (36 arrows);
- 70m (36 arrows);
- 60m (36 arrows);
- 50m for U18 Women and 50+ Women (122cm face);
- 50m (36 arrows on a 80cm face);
- 40m for U18 Women and 50+ Women;
- 30m (36 arrows).

*World Records for the above distances may only be shot as part of the 1440 Round.*

- 70m Round (72 arrows);
- Double 70m Round (144 arrows);
- 60m Round for U18 and 50+ (72 arrows);
- Double 60m Round for U18 and 50+ (144 arrows);

- *Team 1440 Round (3 X 144 arrows);*
- *Team 70m Round (3 X 72 arrows);*
- *Team 60m Round for U18 (3 X 72 arrows);*
- *Compound 50m Round (72 arrows);*
- *Compound Double 50m Round (144 arrows);*
- *Compound 50m Team Round (3x72 arrows);*
- *Individual Compound Match Round (15 arrows);*
- *Compound Team Match Round (24 arrows);*
- *Compound Mixed Team Round (16 arrows);*
- *Mixed Team 70m Round (144 arrows);*
- *Mixed Team 60m Round (144 arrows);*
- *Mixed Team 50m Round (144 arrows);*
- *Barebow 50m Round (72 arrows);*
- *Barebow Double 50m Round (144 arrows);*
- *Barebow 50m Team Round (3x72 arrows);*
- *Mixed Team Barebow 50m Round (2x72 arrows).*

#### 5.3.1.2.

*For Indoor Archery for U18 Women, U18 Men, U21 Women, U21 Men, Women, Men, 50+ Women and 50+ Men in the Recurve, Barebow and Compound Divisions:*

- *25m;*
- *18m;*
- *Indoor Compound Match Team Round (24 arrows);*
- *Indoor Compound Match Individual Round (15 arrows).*

#### 5.3.1.3.

*For Flight Shooting for Women, Men, U21 Women and U21 Men for the World Archery Events listed in Article 32.5.4. World Archery Events, Book 5.*

#### 5.3.1.4.

For Para-Archery see [Chapter 21 - Para-Archery, Book 3](#).

## AC 5.3 CANADIAN RECORDS

### AC 5.3.1

There shall be the following Canadian records recorded by Archery Canada.

#### AC 5.3.1.0

Separate records will be kept for:

- The Canadian Championships (CC);
- Open tournaments (OPEN); and
- Men and Women as applicable to each round, distance and category.

#### AC 5.3.1.1

For Outdoor Target Archery, records for all Archery Canada competition categories (except U10 and Hunter) for the following rounds and matches will be kept.

All Divisions:

- Individual 1440 Round (144 arrows) – all distances;
- Individual Canadian 1200 round (120 arrows) – 70m, 60m, 50m, 40m;
- Individual Canadian 900 round (90 arrows) – 55m, 45m, 35m;

For each of the above rounds, records will be kept for the total round and for each distance as appropriate for the category.

- Records for the individual distances may only be shot as part of the complete Round.

**Recurve:**

- Individual 70 metre Round (72 arrows);
- Individual 60 metre Round (50+ & U18) (72 arrows);
- Individual 50 metre Round (U15) (72 arrows);
- Individual 30 metre Round (U13) (72 arrows);
- Recurve (Olympic) Team Qualification Round (3x72 arrows);
- Recurve (Olympic) Mixed Team Qualification Round (2x72 arrows).

**Barebow:**

- Individual 50 metre Round (Senior, 50+, U21, U18) (72 arrows);
- Individual 40 metre Round (U15) (72 arrows);
- Individual 30 metre Round (U13) (72 arrows);
- Barebow Team Qualification Round (3x72 arrows);
- Barebow Mixed Team Qualification Round (2x72 arrows).

**Compound, Unlimited, Fixed Pins:**

- Individual Outdoor Compound xxx [WA 50 m] Round (72 arrows);
- Individual Outdoor Compound [40m] Round for U15 (72 arrows);
- Individual Outdoor Compound [30m] Round for U13 (72 arrows);
- Individual Compound Match Round (15 arrows);
- Compound Team Qualification Round (3x72 arrows);
- Compound Mixed Team Qualification Round (2x72 arrows);
- Compound Team Round (24 arrows);
- Compound Mixed Team Round (16 arrows).

**AC 5.3.1.2**

For Indoor Target Archery, records will be kept for all Archery Canada competition categories (except U10 & Hunter) for the following rounds:

- Individual 25 m Round (60 arrows);
- Individual 18 m Round (60 arrows);
- Indoor Compound Match Individual Round;
- Indoor Compound Match Team Round ().

**AC 5.3.1.3**

Records for Flight Archery are not recorded in Canada.

**AC 5.3.1.4**

For Para-Archery, records will be kept for the following competition categories for the following rounds and matches:

- Individual Para W1 Open (50m Round);
- Individual Para Recurve Open (70m Round);
- Individual Para Compound Open (50m Round);
- Individual Para W1 Open (18m & 25m Rounds);
- Individual Para Recurve Open (18m & 25m Rounds);
- Individual Para Compound Open (18m & 25m Rounds);
- Doubles Para W1 Open Qualification Round (2x72 Arrows);
- Doubles Para Recurve Open Qualification Round (2x72 Arrows);
- Doubles Para Compound Open Qualification Round (2x72 Arrows);
- Doubles Para W1 Open Match Round (16 arrows);
- Doubles Para Compound Open Match Round (16 arrows);
- Mixed Team Para W1 Open Qualification Round (2x72 Arrows);
- Mixed Team Para Recurve Open Qualification Round (2x72 Arrows);

- Mixed Team Para Compound Open Qualification Round (2x72 Arrows);
- Mixed Team Para W1 Open Match Round (16 arrows);
- Mixed Team Para Compound Open Match Round (16 arrows).

#### **AC 5.3.1.5**

For Field Archery, records will be kept for all Archery Canada competition categories (except U10 & Hunter) for:

- Individual Field Archery Round - marked course (24 targets - 72 arrows).

#### **AC 5.3.2**

In all disciplines, a round total record may be claimed in an age class for which the athlete would be eligible, regardless of which age class in which the athlete actually registered, provided that all distances are the same for each class.

Distance records in Outdoor Target rounds may be shot in any round of the same kind. For example, a U15 athlete shooting as a U18 could claim a U15, U18 and/or U21 1440 Round 30m record, provided it was shot in a 1440 Round, but he could not claim the U15 or U21 1440 Round total record because the distances differ.

[AC Note: *World Archery does not allow World Records for a round or for a distance unless the score is shot in a 1440 Round with all the same distances being shot as are shot by the age class for which the record is being claimed. For example, a U18 could NOT claim a 30m record if it was shot in a 1440 Round for U21s.*]

#### **AC 5.3.3**

In the event that Archery Canada changes rules governing divisions, classes or rounds (including scoring procedure or target size):

##### **AC 5.3.3.1**

Records may be carried forward to the new division, class, or round provided the new rules do not make attaining a record score easier as determined by a majority vote of the AC Board of Directors;

##### **AC 5.3.3.2**

In the case that records are retired, they will be archived and displayed on the Archery Canada website separately from current records.

#### **AC 5.3.4**

60+ Canadian records are recorded only in the disciplines of Target Archery and Field Archery for athletes who are 60 or older on December 31 of the year in which a score is shot.

##### **AC 5.3.4.1**

In the disciplines of Target Archery and Field Archery, a 60+ athlete may claim an Open 60+ (Men or Women) record in a round eligible for Archery Canada records listed above.

##### **AC 5.3.4.1.1**

An athlete over 60 years of age must register for an Archery Canada target or field tournament in one of the competition classes - i.e., Senior or 50+.

##### **AC 5.3.4.1.2**

No Canadian Championship (CC) records are kept for this age class.

##### **AC 5.3.4.2**

In the disciplines of 3D Archery, 60+ is a competitive category. No records are kept in 3D Archery. Medals are awarded for the 60+ class only in the discipline of 3D Archery.

## **5.4. WORLD RECORD TOURNAMENTS**

### **5.4.1.**

The following tournaments are considered automatically as World Record Tournaments:

- Olympic and Paralympic Games;
- World Championships;
- World Ranking Tournaments.

All other tournaments are not automatically considered as World Record tournaments and need to comply with all the requirements as specified in [Article 4.8.2.](#) and [Article 5.5.1.](#)



**5.4.2.**

All Target Archery tournaments complying with [Article 4.8.2.](#) shall also be valid for recognition of World Records as defined in [5.2. World Records - Definition.](#)

**5.4.2.1**

Indoor Rounds shot under outdoor conditions shall also be valid for recognition of World Records.

**5.4.3.**

Team World Records may be established at an event at which there is competition between at least three teams from different countries.

**AC 5.4 CANADIAN RECORD TOURNAMENTS****AC 5.4.1**

The following tournaments are considered automatically as Canadian Record Tournaments:

- Olympic and Paralympic Games;
- World Championships;
- World Ranking Tournaments;
- Continental Championships:
  - Pan American Championships;
  - Pan American Games;
  - Multisite Indoor Championship of Americas.
- Canadian Championships;
- Canadian Team Trials;
- Other Major Tournaments:
  - Canada Games;
  - Canada Cup East;
  - Canada Cup West.
- Any Canadian tournament registered with Archery Canada or World Archery.

**AC 5.4.2**

All tournaments for the disciplines of Outdoor Target, Indoor Target, and Field Archery which are recognized by Archery Canada and are registered with World Archery or with Archery Canada, will be valid for recognition of Canadian Records, provided:

- They are officiated by Judges approved by Archery Canada or by another Member Association of World Archery and
- They are run consistent with Archery Canada rules.

**AC 5.4.4**

Special approval from the Archery Canada Board of Directors may be obtained in advance for scores shot at certain Canadian events which are not listed in [Article AC 4.5](#) to count for Canadian records.

For example, matches shot at a Round Robin style event, may qualify for records if so approved.

An application must be made in writing to the Archery Canada Executive Director at least 30 days in advance of the event.

**5.5. CONFIRMATION OF WORLD RECORDS****5.5.1.**

World Records shot at Olympic and Paralympic Games, World Championships and World Ranking Events are confirmed automatically as soon as the scores are official. Records shot at other tournaments complying with [Article 4.8.2.](#) are subject to confirmation by the Secretary General.

**5.5.1.1.**

*Scores shot at other tournaments shall be sent to the Secretary General no later than 10 days after the tournament.*

*Anyone can claim a record. A claim shall be accompanied by the declaration of the Member Association under the control of which the tournament was organised, including:*

- *The name, description, place and date of the tournament;*
- *Confirmation that the tournament was shot under World Archery Rules;*
- *Confirmation that the athlete(s) was a member of a Member Association at the time;*
- *Name, nationality and category of the athlete(s);*
- *A complete results list;*
- *Details of the record claimed, and supported by the original scorecard or a properly witnessed copy;*
- *Details of the international classification in case a para-athlete claims a World Record or a Para-Archery World Record.*

#### **5.5.1.2.**

*The Secretary General shall review a claim for a World Record upon its receipt.*

#### **5.5.1.3.**

*Should a World Record be broken by two or more equal scores made on the same day, the athletes shall be declared joint World Record holders.*

*For Mixed Team Round. If two athletes of the same gender shoot the same Qualification Round score, the athlete having a higher number of 10's and/or X's will be the record holder. In case the two have the same number of 10's and X's they will be joint record holder with the athlete from the other gender.*

*For Men or Women Teams at events where four archers from the same country compete in the Qualification Round in one category, if the third and fourth ranked archers in the team shoot the same Qualification Round score, the athlete having a higher number of 10's and/or X's will be the record holder. In case the two have the same number of 10's and X's, they will be joint record holders with the other two archers in their team.*

#### **5.5.1.4.**

*World Record holders shall be presented with a diploma stating the result and the place of the record.*

## **AC 5.5 CONFIRMATION OF CANADIAN RECORDS – PROCEDURES**

### **AC 5.5.1**

Canadian records will be subject to confirmation by the AC Records Coordinator.

### **AC 5.5.2**

Claims for records must be submitted to the AC Records Coordinator within 30 days after the tournament in question. A claim for a record shall contain:

- Athlete's name and AC registrant number;
- Athlete's year of birth;
- Athlete's mailing address;
- Athlete's shooting discipline and category (division, gender, age);
- Specification of the record being claimed (distance(s) and/or total);
- Name, description, place and date of the tournament;
- Name of a Judge at the tournament;
- Copy of the original scorecard, signed by the athlete and by the person who completed the scorecard, or by the second scorer if the athlete claiming the record, was the scorer. The name of the witness or second scorer should be printed legibly on the card or in the record claim.

### **AC 5.5.3**

Records may be granted up to 180 days following a tournament if substantiating evidence is provided in addition to the above information. Such evidence will take the form of a signed statement attesting to the record from a Judge who officiated at the tournament or from the tournament organizer who verifies the record from a copy of the scorecard collected at the tournament.

[AC Note: *World Archery allows 10 days for a World Record application, and the application must be made through Archery Canada.*]

#### **AC 5.5.4**

The Records Coordinator will ratify a claim for a Canadian record immediately upon its receipt. The Records Coordinator will maintain a record book with a copy of the scorecard and record claim.

#### **AC 5.5.5**

See [Article AC 5.2.2.](#) regarding records of perfect scores.

#### **AC 5.5.6**

Individual Canadian Record Holders will be mailed a letter of confirmation stating the date, place and specifying the record score(s). The President of Archery Canada or his delegate will sign the letter.

#### **AC 5.5.7**

If an athlete is refused a record, he may apply to the AC Records Coordinator to have the record claim reviewed by an Appeal Board. Upon receipt of such application, the Records Coordinator will immediately notify the AC President, who will convene an Appeal Board consisting of the President and two members of the Executive Board of Directors or Committee Chairpersons. The Appeal Board will review the record claim and decide the issue by majority vote within 30 days of receiving the application.

#### **AC 5.5.8**

Any Archery Canada registrant may challenge a record that has been granted within 60 days of its being posted on the AC website. A challenge must clearly identify the record in question and the grounds for the challenge and should include any supporting documentation. Upon receipt of such a challenge, the Records Coordinator will immediately notify the AC President, who will convene an Appeal Board consistent with Article AC 5.5.7.

### **5.6. OLYMPIC RECORDS**

#### **5.6.1.**

There shall be Olympic Records for:

##### **5.6.1.1.**

*Individual: Women and Men:*

- *70m Round (72 arrows);*

##### **5.6.1.2.**

*Teams: Women and Men:*

- *70m Round (3 x 72 arrows).*

##### **5.6.1.3**

*Mixed Teams: 1 Woman and 1 Man:*

- *70m Round (2 x 72 arrows).*

### **5.7. CONFIRMATION OF OLYMPIC RECORDS**

#### **5.7.1.**

Olympic Records are confirmed automatically as soon as the scores are official.

### **AC 5.8 ELIGIBILITY FOR CANADIAN RECORDS**

#### **AC 5.8.1**

An athlete may only set a record in the equipment division he registered in before the tournament begins.

#### **AC 5.8.2**

An athlete may be granted a Canadian record for a score in a given tournament for any age class in which he was eligible to register (regardless of the age class in which he actually registered), provided that the distances and target sizes for the age class(es) in which the record is being claimed are identical to the distances and target sizes actually shot for the record score in question.

### **AC 5.8.3**

A record may be claimed only by, or on behalf of, an athlete who, at the time of the tournament in question, was a registrant in good standing of Archery Canada and was a citizen of Canada.

## **AC 5.9 PUBLICATION OF CANADIAN RECORDS**

### **AC 5.9.1**

Archery Canada records will be published on the Archery Canada website following notification by the AC Records Coordinator of any new record.

## CHAPTER 6 - MEDALS, TROPHIES AND PERFORMANCE AWARDS

### 6.1. MEDALS

#### 6.1.1.

Championship medals shall be awarded to first, second and third in each event.

### AC 6.1 MEDALS - CANADA

#### AC 6.1.1.

Championship medals shall be awarded to first, second and third in each event.

#### AC 6.1.1.1

Archery Canada Championship Medals shall not be awarded for any event other than Canadian Championships.

### 6.2. PRIZES AND TROPHIES

#### 6.2.1.

At World Championships diplomas shall be awarded to the top eight individual athletes in each event.

#### 6.2.2.

At Championships prizes shall be awarded to the top three individual athletes in the Qualification Round.

#### 6.2.2.1.

*The organisers may award other prizes at their discretion.*

### AC 6.2 PRIZES AND TROPHIES - CANADA

#### AC 6.2.1

Diplomas or other recognition may be awarded at the discretion of the Organizers.

#### AC 6.2.1.1

Certificates of participation should be awarded to participants in the U10 class.

#### AC 6.2.3

The Fred Usher Memorial Cup will be awarded to the Team winners of the Fred Usher Memorial Cup event. A plaque bearing the year and the name of the team, or the names of the team members in the case of an Individual Team, will be added to the trophy.

#### AC 6.2.4 (new for 2024)

Six-for-Sixty Pins are awarded to athletes who:

- at Archery Canada registered indoor target events score 60 points in two consecutive ends;
- at Archery Canada registered outdoor target events score 60 points in one end.

Athletes are charged for these pins.

### 6.3. PERFORMANCE AWARDS

#### 6.3.1.

The performance awards shall be granted when the athlete achieves the relevant scores for the first time in the appropriate event.

#### 6.3.1.1.

*Only one performance award can be claimed for each score.*

#### 6.3.2.

For the 1440 Round there shall be World Archery Stars in relation to the scores obtained as follows:

**6.3.2.1.**

*Recurve Division: The World Archery Star on a shield:*

<b>WORLD ARCHERY STARS AWARD – Recurve</b>					
<b>Star</b>	<b>Star on Black</b>	<b>Star on Blue</b>	<b>Star on Red</b>	<b>Star on Gold</b>	<b>Star on Purple</b>
Men and Women 1000 points	1100 Points	1200 Points	1300 points	1350 points	1400 points

**6.3.2.2.**

*Compound Division: The World Archery Star on a circular background:*

<b>WORLD ARCHERY STARS AWARD – Compound</b>					
<b>Star</b>	<b>Star on Black</b>	<b>Star on Blue</b>	<b>Star on Red</b>	<b>Star on Gold</b>	<b>Star on Purple</b>
Men and Women 1000 points	1100 Points	1200 Points	1300 points	1350 points	1400 points

**6.3.2.3.**

*Silver Star Award: For U18 and 50+ Recurve and Compound Division*

<b>SILVER STAR AWARD – Recurve and Compound</b>					
<b>Star</b>	<b>Star on Black</b>	<b>Star on Blue</b>	<b>Star on Red</b>	<b>Star on Gold</b>	<b>Star on Purple</b>
Men and Women 1000 points	1100 Points	1200 Points	1300 points	1350 points	1400 points

**6.3.3.**

For other Target Archery Rounds there shall be Target Awards:

**6.3.3.1.**

*These badges shall be on a circular coloured background and awarded for the scores set out in the chart below and for the following Rounds:*

- 0m Round (Recurve only);
- 900 Round;
- 25m Round;
- 18m Round;
- 18m Round (Barebow);
- 50m Compound Round (Compound only);
- 50m Barebow Round (Barebow only).

<b>TARGET AWARD - Recurve + Compound</b>						
<b>Target</b>	<b>White</b>	<b>Black</b>	<b>Blue</b>	<b>Red</b>	<b>Gold</b>	<b>Purple</b>
70m Round	500	550	600	650	675	700
900 Round	750	800	830	860	875	890
25m Round	500	525	550	575	585	595
18m Round	500	525	550	575	585	595
50m Compound Round	500	550	600	650	675	700
50m Barebow Round	480	500	550	600	625	640

**6.3.3.2.**

*There shall be Silver Target Awards for 50+ and U18 Classes:*

- 60m Round (recurve only).

<b>SILVER TARGET AWARD - Recurve + Compound</b>						
<b>Target</b>	<b>on White</b>	<b>on Black</b>	<b>on Blue</b>	<b>on Red</b>	<b>on Gold</b>	<b>on Purple</b>
60m Round	500	550	600	650	675	700

**6.3.3.3.**

*Only one Target Award in each colour may be claimed, regardless of the round shot.*

**6.3.4.**

For the Arrowhead Round there shall be World Archery Arrowhead Badges:

**6.3.4.1.**

These badges shall be awarded for the Recurve Division as follows:

<b>WORLD ARCHERY ARROWHEAD BADGES - Recurve</b>				
	<b>24 targets</b>		<b>48 targets</b>	
	<b>Men</b>	<b>Women</b>	<b>Men</b>	<b>Women</b>
<i>Green</i>	219	196	438	392
<i>Grey</i>	275	257	550	514
<i>White</i>	309	293	618	586
<i>Black</i>	333	320	666	640
<i>Gold</i>	351	340	702	680

**6.3.4.2.**

These badges shall be awarded for the Barebow Division as follows:

<b>WORLD ARCHERY ARROWHEAD BADGES- Barebow</b>				
	<b>24 targets</b>		<b>48 targets</b>	
	<b>Men</b>	<b>Women</b>	<b>Men</b>	<b>Women</b>
<i>Green</i>	191	182	382	364
<i>Grey</i>	250	238	500	476
<i>White</i>	287	272	574	544
<i>Black</i>	315	295	630	590
<i>Gold</i>	336	313	672	626

**6.3.4.3.**

These badges shall be awarded for the Compound Division as follows:

<b>WORLD ARCHERY ARROWHEAD BADGES- Compound</b>				
	<b>24 targets</b>		<b>48 targets</b>	
	<b>Men</b>	<b>Women</b>	<b>Men</b>	<b>Women</b>
<i>Green</i>	292	275	584	550
<i>Grey</i>	340	325	680	650
<i>White</i>	367	352	734	704
<i>Black</i>	387	373	774	746
<i>Gold</i>	401	389	802	778

**6.3.4.4.**

The Green and Grey Arrowhead may be obtained by the U18 on their specific rounds. U21 can obtain all Arrowheads since they shoot the same distances as the Men and Women.

**AC 6.3 PERFORMANCE AWARDS****AC 6.3.0**

World Archery performance awards may be granted to qualifying Canadian registrants upon application.

- WA Star awards are provided through a standing program of Archery Canada.
- Other performance awards may be acquired on a case basis by application to the Archery Canada office.

**6.4. EVENTS FOR PERFORMANCE AWARDS****6.4.1.**

The Star Awards can be gained on the scores obtained in a 1440 Round or in either 1440 Round of a Double 1440 Round, when organised in accordance with [Article 6.5. Applications for Awards](#).

**6.4.2.**

The performance awards can be gained at tournaments organised by Member Associations and recognised by World Archery (see [Article 4.8. Official Recognition of Tournaments](#)) for which the Member Association shall pay a fee established by the Executive Board within the maximum amount established by Congress.

## 6.5. APPLICATIONS FOR AWARDS

### 6.5.1.

Supplies of performance awards shall be sent to Member Associations in the numbers requested, except for the higher value performance awards.

#### 6.5.1.1.

*The higher value performance awards are:*

- *1350 and 1400 Star Awards;*
- *1350 and 1400 Silver Star Awards;*
- *Gold and Purple Target Awards;*
- *Gold and Purple Silver Target Awards;*
- *Gold Arrowhead badges.*

### 6.5.2.

The Member Association shall be responsible for:

#### 6.5.2.1.

*Paying for such awards, except higher value awards which are provided by World Archery free of charge.*

#### 6.5.2.2.

*Recording the name or description, place and date of the tournament.*

#### 6.5.2.3.

*Verifying that the tournament was shot according to World Archery Rules.*

#### 6.5.2.4.

*Verifying that all athletes whose applications are submitted were affiliated to a Member Association at the time of the tournament.*

#### 6.5.2.5.

*Verifying the correctness of the original scorecards or a properly witnessed copy that shall accompany each application.*

### 6.5.3.

*Applications for the higher awards shall be sent to the Secretary General on behalf of the applicants by their Member Associations.*

#### 6.5.3.1.

*Applications shall:*

- *Indicate the name and class of the applicants;*
- *Indicate the names, places and dates of the tournaments;*
- *Provide a statement of compliance with 6.5.2.3., 6.5.2.4. and 6.5.2.5.;*
- *Be accompanied by the original scorecard or a properly witnessed copy and a complete results list.*

#### 6.5.3.2.

*The Secretary General, if satisfied with the documentation received, shall forward the performance awards through the Member Association free of charge and shall periodically publish lists.*

## AC 6.5. APPLICATIONS FOR AWARDS - CANADA

### AC 6.5.1.

Supplies of only some performance awards are maintained by Archery Canada, including:

- **WA Star.**



### **AC 6.5.2**

Participants are responsible for the requirements of [Article 6.5.2](#). An application is deemed to be a declaration that the requirements have been met and will be verified by Archery Canada.

### **AC 6.5.3**

Registrants may apply for a performance award through an application to the Archery Canada designated coordinator (see [archerycanada.ca](http://archerycanada.ca)).

## CHAPTER 7 - FIELD OF PLAY SETUP - TARGET ROUNDS

### 7.1. FIELD OF PLAY LAYOUT

#### 7.1.1.

The field of play shall comply with the following provisions:

##### 7.1.1.1.

*The field of play shall be established with corners of 90 degree angles. Each distance shall be accurately measured from a point vertically beneath the gold of each target face to the shooting line.*

*The tolerance for distances is at 90/70/60m  $\pm$ 30cm; at 50/40/30m  $\pm$ 15cm; at 25/18m  $\pm$ 10cm.*

##### AC7.1.1.1

*The tolerance for distances is at 90/70/60/55m  $\pm$ 30cm; at 50/45/40/35/30m  $\pm$ 15cm, at 25/18m  $\pm$ 10cm.*

##### 7.1.1.2.

*A waiting line shall be marked at least 5m behind the shooting line outdoors and at least 3m indoors. A media line shall be marked one meter in front of the waiting line.*

##### 7.1.1.3.

*Each target butt outdoors shall be set up at an angle of between 10 and 15 degrees from vertical and between 0 and 10 degrees indoors, but a line of target butts shall be set up all at the same angle.*

##### 7.1.1.4.

*The height of the centres of the target faces in a line of target butts should look straight at all times.*

##### 7.1.1.5.

*All athletes in a category shall be assigned to one field of play.*

##### 7.1.1.6.

*Whenever possible three athletes per target shall be assigned. If the field of play does not permit this, four athletes shall be the maximum number per target butt.*

##### 7.1.1.7.

*There shall be a mark on the shooting line directly opposite each target butt. There shall also be a number corresponding to that target butt 4 metres in front of the shooting line. If two or more athletes are shooting at the same target butt at the same time, the shooting position or shooting space for each one of them shall be marked on the shooting line. A minimum space of 80cm per athlete for indoor rounds, and a minimum space of 90cm per athlete for outdoor rounds shall be guaranteed. ([Article 21.11.4., Book 3](#))*

##### 7.1.1.8.

*The field of play shall be divided into shooting lanes containing one to four butts. These lanes shall be marked by lines extending at right angles from the shooting line to the target line.*

##### 7.1.1.9.

*A line parallel to the shooting line shall be marked 3m in front of the shooting line.*

##### 7.1.1.10.

*Suitable barriers for the public shall be erected to keep spectators safe. Consideration should be given to any distractions caused to the athletes by movement of people, etc. behind the butts.*

*Outdoors these barriers shall be at least 20m away from the sides of the first and last target set at 90m. This distance may be reduced in a straight line to a minimum of 10m away from the ends at the shooting line. This shall maintain a margin of approximately 13m from the target line when the target butts are moved to 30m. The barriers shall be at least 10m behind the waiting line. The barriers shall be set at least 50m beyond the 90m target line. This shall create a safety zone increasing to 110m when target butts have been moved forward to 30m. The safety distance of 50m may be reduced if an adequate backstop, e.g.*

efficient netting, a bank or similar device, is erected (not a hedge or penetrable fence). The backstop shall be high enough to stop arrows which have just missed the top of the butt at 90m.

Indoors where the size of the hall dictates, suitable barriers shall be erected around the range to keep spectators back. These barriers shall be at least 10m from the ends of the target line and shall be at a minimum of 5m behind the waiting line. No spectators are allowed beyond the target line. Where the size of the hall does not require the erection of side barriers no spectators are allowed beyond the barrier situated behind the waiting line.

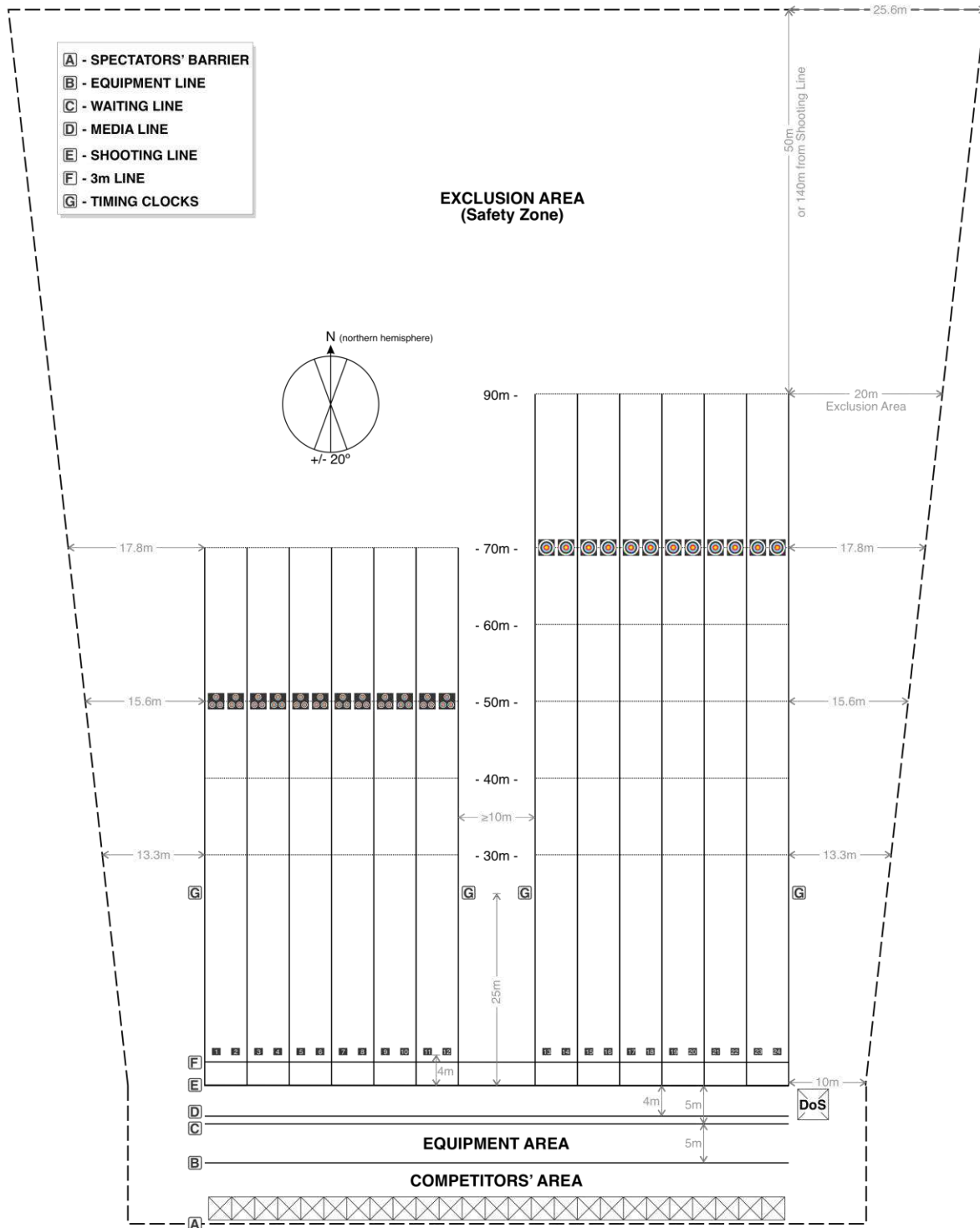

Image 1: Range Layout (AC version of image)

**7.1.1.11.**

*In the Elimination Rounds, target butts are to be arranged in closely set pairs.*

**7.1.1.12.**

*For the Olympic and Compound Match Rounds a practice field shall be made available alongside the competition field, where athletes still in the competition may practice during the Elimination and Finals Round.*

**7.1.1.13.**

*For the Team Rounds a clearly visible line shall be marked 1m behind the shooting line. This line shall be at least 3cm wide.*

**7.1.1.14.**

*For the Team Rounds there shall be an athletes' area marked behind the 1m line, giving reasonable space for three athletes and their equipment and a coach's area behind the athletes' area. If space allows, there shall also be a small area marked for the Judge between the two competing teams.*

**7.2. VENUE EQUIPMENT AND SCORING ZONES****7.2.1. Butts (buttresses)**

The size of the front of the butt, whether round or square, shall be large enough to ensure that any arrow hitting the butt and just missing the outermost edge of the scoring zone remains in the butt. The arrows hitting shall remain embedded in the butt to allow proper scoring.

**7.2.1.1.**

*Butts shall be firmly attached to supports, which shall be pegged securely in the ground to prevent them from being blown or pulled over. Any part of the butt or its support likely to damage an arrow shall be covered. Care is necessary, particularly when more than one target face is placed on the butt, that arrows passing through the butt are not damaged by the support. See Outdoor target butt set-up for outdoor and Indoor target butt set-up for indoor target butt drawing.*

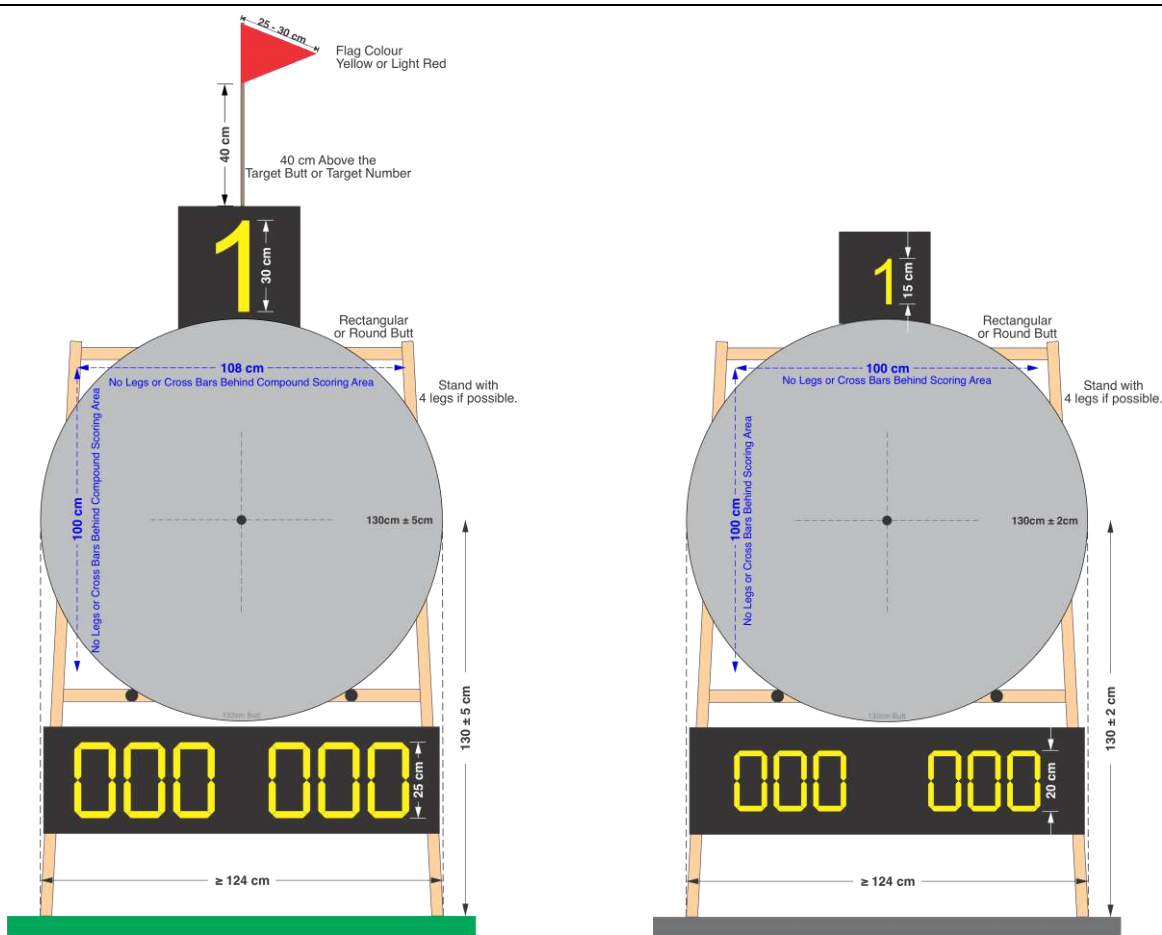

**Image 2: Outdoor Target Butt Setup** (AC version of Image) **Image 3: Indoor Target Butt Setup** (AC version of Image)

**7.2.1.2.**

Each butt shall have a target number. These numbers shall be minimum 30cm tall (for Outdoor Rounds) and minimum 15cm (for Indoor Rounds). Target numbers shall be fixed above or below the centre of each target butt, so they are clear of the target face.

**7.2.2. TARGET FACES**

There are four outdoor target faces:

- The 122cm face, 122cm in diameter;
- The 80cm face, 80cm in diameter;
- The 80cm 6-ring face (for multiple set-ups with score zones 5-10);
- The Academic Round Hit/miss face.

There are 10 indoor target faces:

- The 60cm diameter face;
- The 60cm triangular triple face;
- The 60cm vertical triple face;
- The 40cm diameter face;
- The 40cm triangular triple face;
- The 40cm vertical triple face
- The 40cm-R triangular triple face;
- The 40cm-C triangular triple face;
- The 40cm-R vertical triple face;

- The 40cm-C vertical triple face.

Only target faces produced by a manufacturer licensed by World Archery shall be used at World Archery competitions.

#### 7.2.2.1.

*Description:*

*The 122cm, 80cm, 60cm and 40cm faces are divided into five concentric colour zones arranged from the centre outwards as follows: yellow (gold), red, light blue, black and white. Each colour is divided by a thin line into two zones of equal width thus making 10 scoring zones of equal width when measured from the centre of the gold:*

- *6.1cm on the 122cm target face;*
- *4cm on the 80cm target face;*
- *3cm on the 60cm face;*
- *2cm on the 40cm face.*

*The dividing lines shall be entirely within the higher scoring zone in each case. There are no dividing lines between light blue and black, nor between black and white. The line marking the outermost edge of the white shall be made entirely within the scoring zone. The width of the thin dividing line and the outermost line shall not exceed 2mm on the target faces. The centre of the target face shall be indicated by a small “+” (cross). The lines of the cross shall not exceed 1mm in width or 4mm in length. An inner 10 ring, (which is marked as an X on the score cards) of 6.1cm in diameter for the 122cm target face and 4cm in diameter for the 80cm target face, is required to help determine ties in ranking. For indoor compound events the 10 ring is 3cm on the 60cm face and 2cm in diameter for the 40cm face.*

- *Outdoors the 80cm 6-ring face may be used at 50m, 40m and 30m. The rings have the same dimensions as the 80cm faces, but with the 4 to 1 scoring zones removed. The lowest scoring zone is the light blue 5.*
- *Indoors triple faces may be used as follows. (For the Indoor Match Round, the 40cm triple face shall be used. R- and C). They have the same dimensions as the World Archery 60cm and 40cm faces respectively, but with the 5 to 1 scoring zones removed. The lowest scoring zone is therefore light blue 6. Each set consists of three small faces on a white background arranged symmetrically in a triangular pattern with the centres respectively bottom left, at the top, and at the bottom right, or in a vertical row. The centres of the golds shall be approximately 32cm distant from each other on 60cm faces and 22cm distant from each other on 40cm faces. There is a distinction between regular triple faces and Recurve (R) and Compound (C) 40cm triple faces. The 40cm triple face (both triangular and vertical) will differ in the size of the 10 ring: the 40cm-R has a 40mm 10 ring, the 40cm-C has a 20mm 10 ring and the combined triple face has the two 10 rings.*

#### AC 7.2.2.1

Target Description and use:

- also ...Outdoor 1440 Round - the 80 cm 6-ring face as well as the full 80cm face may be used at 30m, 25m and 20m (short distances) for U15 and U13.
- also ...Outdoor 1440 Round - the 80 cm ~~5-ring face~~ or 6-ring face, as well as the full 80cm face, may be used at 25m and 20m (shortest distances) for U15 and U13.
- also ...Indoor 18m Round - the 40 cm triple face as well as the full 40cm face may be used at 18m, and the 60cm triple face, as well as the full 60cm face, may be used for U15 Recurve and Barebow and all U13 categories.
- also ...Indoor Match Rounds - other than World Archery events, the 40cm triple or full faces (and the 60cm triple or full faces for U15 Recurve & Barebow and all U13) may be used.

## 7.2.2.2.

Scoring values and colour specifications:

Scoring values	Colors	Pantone code
10	Yellow	107U
9	Yellow	107U
8	Red	032U
7	Red	032U
6	Light Blue	306U
5	Light Blue	306U
4	Black	Process Black
3	Black	Process Black
2	White	-
1	White	-

## 7.2.2.3.

Tolerance of measurement:

Outdoors the target face shall be measured using the diameter of each separate circle enclosing each of the scoring zones. The tolerance of each diameter shall not exceed  $\pm 1\text{mm}$  for the scoring zones 10, 9, 8 and hit zone and  $\pm 2\text{mm}$  for the other scoring zones measured through the centre.

Scoring values	Diameter in cm		Tolerance in mm $\pm$
	122	80	
Inner 10	6.1	4	1
10	12.2	8	1
9	24.4	16	1
8	36.6	24	1
7	48.8	32	2
6	61	40	2
5	73.2	48	2
4	85.4	56	2
3	97.6	64	2
2	109.8	72	2
1	122	80	2

Indoors the target face shall be measured using the diameter of each separate circle enclosing each of the 10 scoring zones. The tolerance of each diameter shall not exceed  $\pm 1\text{mm}$  for the scoring zones 10, 9 and 8 and  $\pm 2\text{mm}$  for the other scoring zones when measured through the centre.

Scoring values	Diameter in cm		Tolerance in mm $\pm$
	60	40	
Compound 10	3	2	1
Recurve 10	6	4	1
9	12	8	1
8	18	12	1
7	24	16	2
6	30	20	2
5	36	24	2
4	42	28	2
3	48	32	2
2	54	36	2
1	60	40	2

For the Compound Division only the inner 10-ring shall score 10, the rest of the yellow scoring zone shall score 9, provided that the Compound W1 Division, with athletes using recurve sights, will use the recurve 4cm 10-ring Target face, see drawing [Image 4](#) 1-10 Scoring Zones Target Face.

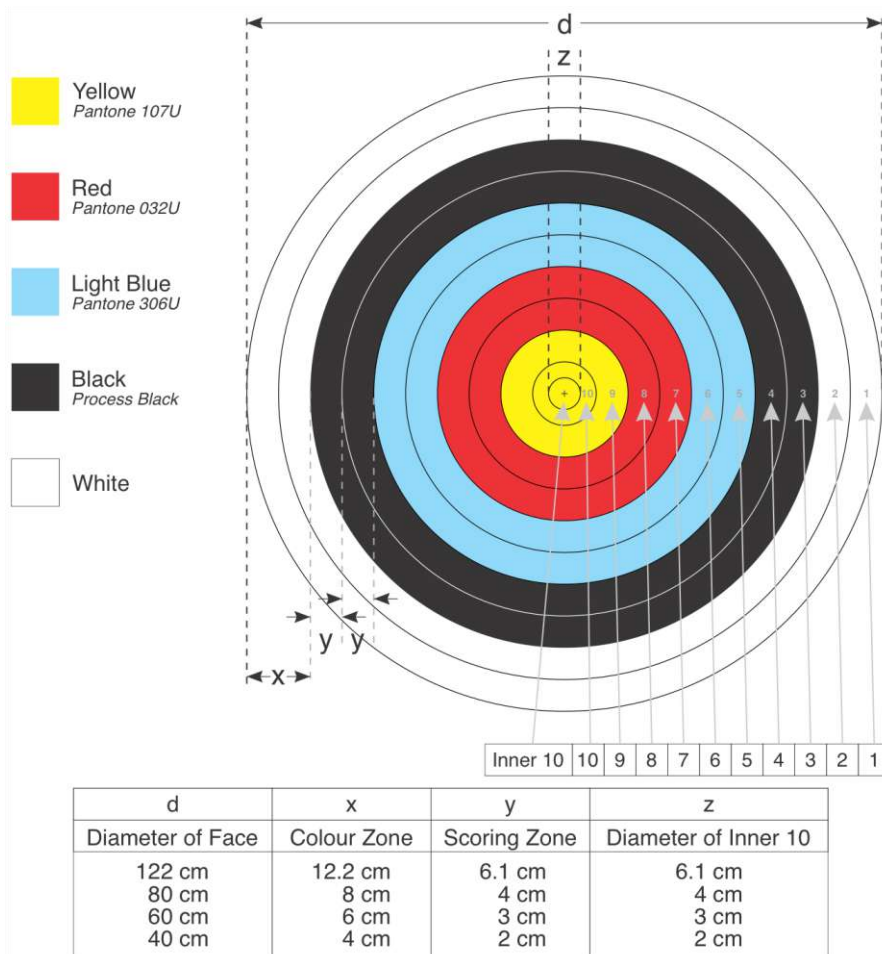

**Image 4:** 1-10 Scoring Zones Target Face (AC version of Image)

**AC 7.2.2.3**

re: Indoor target scoring

For all Categories shooting the compound bow divisions (except para-compound W1 division) in Canada....

For the indoor 18m and 25m Rounds:

- The Compound target face will be used; OR
- If the combined target face is used;
- Only the inner Compound 10-ring shall score 10. The rest of the yellow scoring zone shall score 9;
- This includes:
  - All Age Classes;
  - Compound Division;
  - Unlimited Division;
  - Fixed Pins Division;
  - (Hunter Division).

For the Para-Compound W1 Division, with athletes using recurve sights....

For the indoor 18m and 25m Rounds:

- The Recurve target face will be used; OR
- If the combined target face is used, the outer Recurve 10-ring shall score 10, and the rest of the yellow scoring zone shall score 9.

For the indoor Canadian 300 Round:

- For all categories, the combined target face must be used: the inner 10 ring shall score “X” with a value 10:
  - The outer 10-ring shall score 10 and;
  - The rest of the yellow scoring zone shall score 9.

See [Image 4: 1-10 Scoring Zones Target Face](#)).



**7.2.2.4.**

*Academic Round Hit/Miss target face:*

**7.2.2.4.1.**

*The Academic Round Target face is a Hit/Miss target consisting of two zones: a hit zone and a miss zone.*

**7.2.2.4.2.**

*The hit-zone (spot) of the target face for 70m has a diameter of 24.4cm.*

**7.2.2.4.3.**

*The colour for the hit-zone (spot) is yellow (Pantone 107U).*

**7.2.2.4.4.**

*The colour for the miss-zone is red (Pantone 032U).*

**7.2.2.5.**

*Material of target faces:*

*Target faces may be made of paper or any other suitable material. All faces used for the same competition category shall be uniform in colour and of the same material.*

**7.2.3.**

*Size of target face at different distances and target set-up outdoors.*

*The 122cm target face shall be used for the distances of 90, 70, 60m (and 50m for U18 and 50+ Women).*

*The 80cm target face shall be used for distances of 50, 40, 30m, except for the Standard Bow Round.*

**7.2.3.1.**

*The centre of the target face shall be 130cm above the ground as measured from ground level. The tolerance of measurement shall not exceed  $\pm 5$ cm.*

**7.2.3.2.**

*When using a triangular multiple-centre face (5 or 6-ring) set-up at 50m, 40m and 30m or the four-centre face setup the maximum distance above the ground of the centre of the upper face(s) shall be 172cm and the minimum distance above the ground of the centre of the lower faces shall be 90cm. The minimum distance between the scoring zones of two faces at the same height shall be 2cm.*

**7.2.3.3.**

*When using a three-centre face (5-ring) horizontal set-up at 30m, the centres of the faces shall be at 130cm ( $\pm 5$ cm) above the ground. The minimum distance between the scoring zones shall be 2cm.*

**7.2.3.4.**

*Setup of target faces for Compound Match Play:*

*80cm 6-ring target faces shall be placed on the target as follows:*

- *For the Eliminations Round (no alternating shooting), one face shall be placed horizontally on the left side of the centre (three arrows to be shot by the left athlete) and one on the right side of the centre (three arrows to be shot by the right athlete);*
- *For the Finals (alternating shooting), one face shall be placed on each target;*
- *For the Team and Mixed Team, each team shall have one target with two faces set up horizontally on the target, one face for three arrows (Team) or two arrows (Mixed Team) (see Image 5: 2 x 5-10 Scoring Zones Target Face). Athletes on a team may elect which face to shoot provided that each face has either three arrows (Team) or two arrows (Mixed Team).*
- *For the Team and Mixed Team, the shoot-off will be shot on a single target face.*

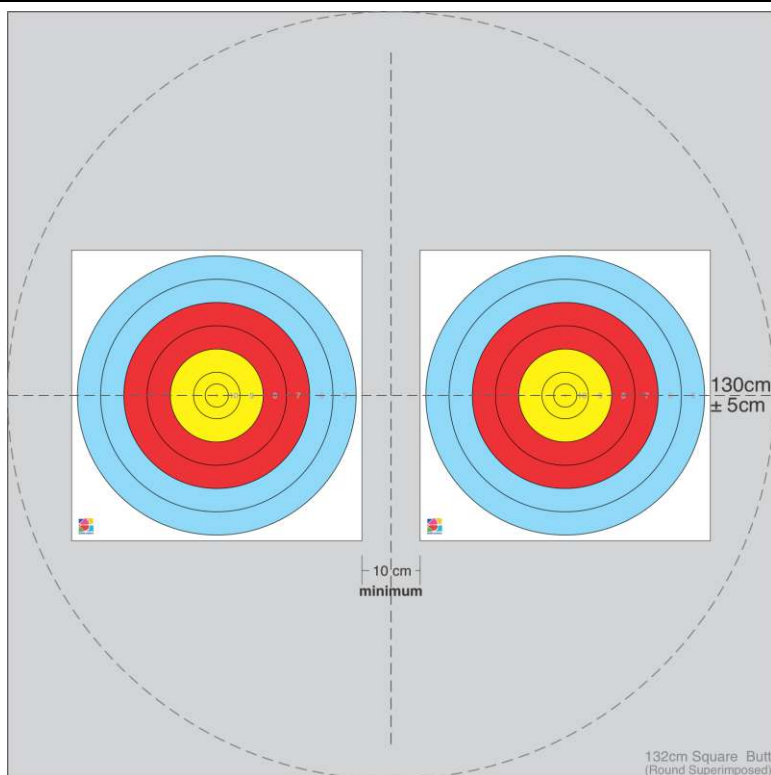

**Image 5:** 2 x 5-10 Scoring Zones Target Face (AC version of Image)

### 7.2.3.5.

*The use of single or 6-ring faces in all other competitions is the choice of the organisers, who can allow the athletes in the same class and division to shoot on a different type of face. For World Championships and Other International Events, the 6-ring face is mandatory except for W1.*

### AC 7.2.3

Size of target face at different distances and target set-up outdoors also ... the 122 cm target face shall be used for:

- The long distances of the 1440 Round for U15 and U13:
  - U15: 50m & 40m;
  - U13: 30m & 25m.
- All distances of the:
  - Canadian 900 Round;
  - Canadian 1200 Round.

- The 720 Rounds for Recurve and Barebow;

also ... the 80 cm target face shall be used for

- The short distances of the 1440 Round for U15 and U13:
  - U15: 30m & 20m;
  - U13: 25m & 20m.
- The 720 Rounds for all compound bow divisions;
- All distances of T2S 900 Round.

### AC 7.2.3.1

except....

- Except when scoreboards are used on the target butt (see [Image 9: Appendix 1, Book 3](#)).

### AC 7.2.3.2 ...

also ... the triangular multiple-centre face (5 or 6-ring) may be used (as well as the single full 80 cm face) for:

- The 30m, 25m and 20m short distances of the 1440 Round for U15 and U13;
- The Compound 720 Rounds at the appropriate distances.

**AC 7.2.3.3 ....**

also,... the three centre (5-ring) horizontal set-up may be used (as well as the single full 80 cm face) for the 25m and 20m shortest distances of the 1440 Round for U15 and U13.

**7.2.4.**

Size of target face at different distances and target set-up indoors. For indoor shooting at 25m, the target face of 60cm shall be used. For the distance of 18m, the target face of 40cm shall be used.

**7.2.4.1.**

*Rounds and faces.*

*For the Indoor Match Round, the triple 40cm faces shall be used. In the Elimination and Finals Rounds the faces shall be set in pairs on each target butt. The use of single or triple faces in all other competitions is the choice of the organisers, who can allow the athletes in the same class and division to shoot on a different type of face.*

**7.2.4.1.1.**

*The set-up for a single face or a pair of faces.*

*The centre of the single face or the centre of the middle face of the vertical triple face shall be 130cm above the floor. When using triangular triple faces the height refers to the two lower centres of the triple faces.*

*When using a pair of faces, the minimum distance between scoring areas of the two faces shall be 10cm. For 60cm faces the distance shall be a minimum of 2cm between the two scoring zones.*

**7.2.4.1.2.**

*Set-up for four 40cm single or triple triangular faces.*

*In case of four 40cm faces, the maximum height of the centres of the upper faces shall be 162cm above the floor. The centres of the lower faces shall be a minimum of 100cm above the floor. In the case of triple triangular 40cm faces, the maximum height refers to the highest centres of the triple faces and the minimum height refers to the lowest centres of the triple faces. The minimum distance between the scoring zones of two faces at the same height shall be 10cm. Each face shall be placed in its quarter of the target butt (see Image 6 and Image 7 below).*

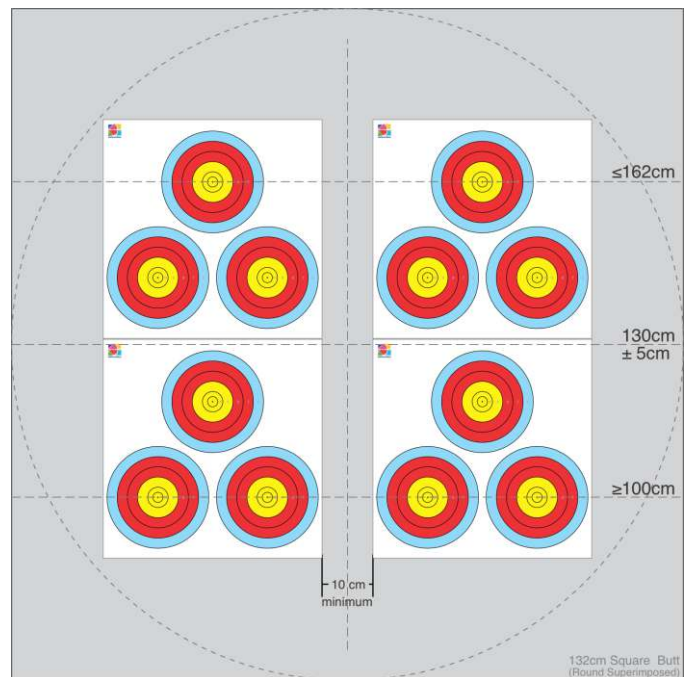
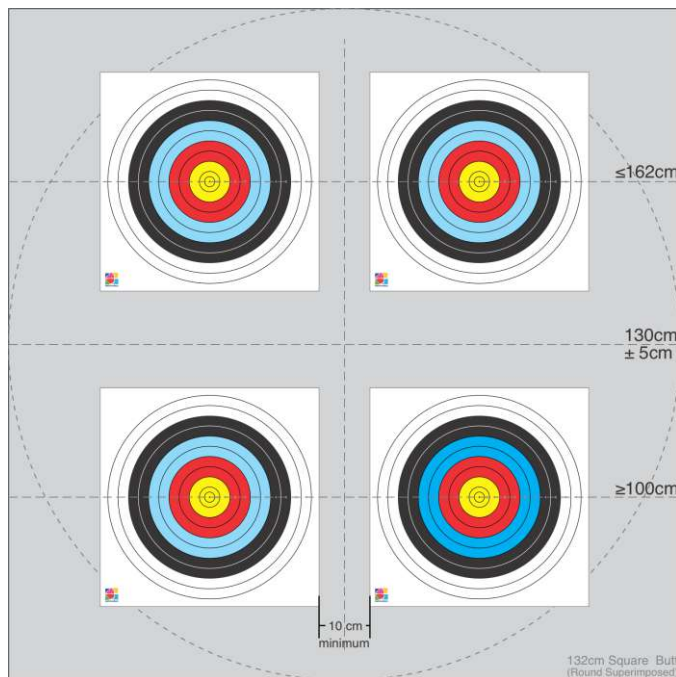

**Image 6:** 4 x 4 40cm Target Face for Indoor (AC version of Images) **Image 7:** 4 x 4 Triple Triangular Face for Indoor (AC version of Images)

### 7.2.4.1.3.

*Set-up for four and two 40cm vertical triple faces.*

*When using four vertical triple 40cm faces, the centres of the middle faces shall be 130cm above the floor.*

*With four vertical triple faces, there shall be a space of at least 10cm between the scoring zones of the second and third column, and a maximum distance of 2cm between the scoring zones of columns 1 and 2, and columns 3 and 4.*

*With two vertical triple faces (individual and team event), there shall be a space of minimum 25cm between the scoring areas of each column.*

*With one vertical triple face set-up horizontally (team shoot-off), the centre of the vertical triple face shall be 130cm above the floor.*

### 7.2.4.1.4.

*The tolerance of measurement shall not exceed  $\pm 2$ cm for the positioning of the target faces.*

## AC 7.2.4

Size of target face at different distances and target set-up indoors:

- At 25m, the target face of 60cm shall be used;
- At 18m:
  - The target face of 40cm shall be used for the following categories:
    - ◆ All 50+, Senior, U21 and U18 categories; and
    - ◆ U15 Compound category.
  - The target face of 60cm shall be used for the following categories:
    - ◆ U15 Recurve and U15 Barebow categories;
    - ◆ All U13 categories.
- U10 class may use any target size appropriate for the participants.

### AC 7.2.4.1

also .... for the Indoor Match Round:

- The full 40cm face or the triple 40cm faces shall be used for:
  - All 50+, Senior, U21 and U18 categories, and
  - U15 Compound category.
- The full 60cm face or the triple 60cm face shall be used for:
  - U15 Recurve and U15 Barebow categories, and
  - All U13 categories.

## 7.2.5. Time Control Equipment.

Acoustic and visual.

The Director of Shooting (see [Article 10.1.1.](#)) shall control:

- The start and end of each time limit with a whistle or another audible indicator;
- Each time limit with digital clocks, lights, flags, plates or any other simple visual indicator in addition to the audible signal referred to above.

### 7.2.5.1.

*In the event of a small discrepancy between the acoustic and the visual time control equipment, the acoustic time control equipment shall take precedence.*

### 7.2.5.2.

*The following equipment can be used:*

- *Lights;*
  - *the colours of the lights shall be red, yellow and green in that order with the red at the top. The lights shall be synchronized and at no time shall two different colours be on at the same time. In Championships, the lights shall*

*be linked with the acoustic equipment so that the first sound of the acoustic equipment is simultaneous with the light turning red and the digital clock reaching zero.*

- **Digital Clocks;**
  - When timing is controlled by the use of digital clocks the figures on the clock shall be a minimum of 20cm in height and shall be able to be clearly read at a distance of 100m. They shall be able to be stopped and reset very quickly as and when required. The clock shall function on a countdown principle. All other requirements shall be the same as for lights.
  - When digital clocks are used, lights are not mandatory.
  - If both systems are used, they must be synchronised. If there is a discrepancy, the digital clock takes precedence.
- *The visual signals are to be placed on both sides of the field and, if necessary, in a clear lane between target butts, at any distance shorter than 30m, so they are visible to all athletes, both left and right-handed, on the shooting line;*
- **Match play indicators;**
  - *When shooting the alternating match play, there shall be separate green/red lights, countdown clocks, or other visual signals for each athlete to indicate whose turn it is to shoot.*
- **Emergency Equipment;**
  - *When the time limit is controlled by electrical equipment, plates, flags or other manual indicators shall be available in case the other equipment fails.*
  - *When the time limit is controlled manually by means of plates, these are a minimum of 120cm by 80cm in size. They shall be securely mounted to resist any wind and shall be easy to turn quickly to show either side. One side of each plate shall be green and the reverse side of each plate shall be yellow.*
- *Lights or digital clocks and emergency equipment are mandatory for International Events.*

#### **7.2.6.**

##### **Miscellaneous Equipment**

The equipment outlined in the bylaws below is mandatory at International Events and is recommended for other important tournaments.

##### **7.2.6.1.**

*Athletes' numbers shall be worn by each athlete.*

##### **7.2.6.2.**

*A device to indicate the order of shooting if the athletes do not all shoot at the same time. The letters shall be large enough to be read by all athletes from their respective shooting positions.*

##### **7.2.6.3.**

*A scoreboard for cumulative totals after each end, for at least the first five athletes of each category and the scores for the qualification cut.*

##### **7.2.6.4.**

*In the Elimination Round a flip-score device to show three digits shall be displayed below each butt.*

##### **7.2.6.5.**

*In the Finals Round, there shall be one remotely-operated scoreboard, one for each athlete (or team), with spaces for the scores of three individual arrows and the total score or sets for each match. There shall also be provision for the athlete's name and country, or the country in the team competition.*

##### **7.2.6.6.**

*Blinds for use in the Finals Rounds may be placed near the butts. They shall be used by Judges, scorers, and athletes' agents.*

##### **7.2.6.7.**

*Outdoors wind flags, of any light material and easily visible colour (such as yellow) to serve as wind indicators, shall be placed above the centre of each butt. They shall be placed 40cm above the butt or the*

*target number, whichever is higher. The flags shall measure not more than 30cm and not less than 25cm in any dimension.*

**7.2.6.8.**

*Outdoors windsocks on both sides of the field and one in the middle when there is a split between the two sides. The windsocks are to be placed between 2.5 and 3.5m above the ground, between the shooting line and the line of targets, and shall be official World Archery windsocks.*

**7.2.6.9.**

*A raised platform with seating facilities for the Director of Shooting.*

**7.2.6.10.**

*An audio system and wireless radios.*

**7.2.6.11.**

*On shooting fields other than the Finals Field or Finals Area of the main field, a sufficient number of chairs or benches placed behind the waiting line for all athletes, Team Managers, coaches and other officials. The chairs for Judges, with some shelter from the weather, should be placed at appropriate places along the waiting line at the Qualification and Elimination Round fields.*

**7.2.6.12.**

*An automatic scoring system may only be used in the Finals Rounds.*

## CHAPTER 8 - FIELD OF PLAY SETUP - FIELD ARCHERY

### 8.1. COURSE LAYOUT

#### 8.1.1.

The field course shall be arranged so that the shooting positions and the targets can be reached without undue difficulty, hazard or waste of time. Field courses should be as condensed as possible.

##### 8.1.1.1.

*The walking distance from the central (assembly) area to the furthest target should be no more than 1km or 15 minutes normal walking.*

##### 8.1.1.2.

*The course makers shall prepare safe paths for Judges, medical personnel and to allow for transportation of equipment round the course(s) while shooting is in progress.*

##### 8.1.1.3.

*The course(s) shall not be positioned higher than 1800m above sea level and the maximum difference between the highest and the lowest point in a course shall not be more than 100m.*

##### 8.1.1.4.

*The targets shall be laid out in such order as to allow maximum variety and best use of the terrain. In the Finals Round two butts shall be placed side by side at each target on which a 60cm or 80cm target face is placed.*

##### 8.1.1.5.

*At all targets, one shooting peg for each distance shall be placed in such a way as to allow at least two athletes to shoot at the same time from either side of the shooting peg.*

##### 8.1.1.6.

*All shooting pegs shall be marked with the distance when marked distances are to be shot. The shooting pegs shall have different colours, corresponding to each group of categories as follows:*

- *Blue for the Barebow, U18 Recurve and U18 Compound;*
- *Red for the Recurve and Compound;*
- *Yellow for the U18 Barebow.*

#### AC 8.1.1.6

*In addition, other Canadian categories shoot from each peg.*

<b>Yellow Peg</b> 5m-40m	<b>Blue Peg</b> 5m-50m	<b>Red Peg</b> 10m-60m
Senior, 50+: Longbow U18: Barebow U15 - all U13 - all	U18: Recurve Compound U21, Senior, 50+: Barebow Senior, 50+: Instinctive*	U21, Senior, 50+: Recurve, Compound Senior: Unlimited, Fixed Pins, (Hunter)

\*- Instinctive (WA Traditional)

##### 8.1.1.7.

*The tolerances are:*

- *For distances 15m or less  $\pm 25$ cm;*
- *For distances between 16-60m  $\pm 1$ m.*

*However, the distances given in [Article 8.1.1.10](#). Unit for Marked Course may be adjusted by  $\pm 2$ m. The correct distance shall be marked on the shooting peg.*

*The distance should be measured in the air approximately 1.5-2m above the ground. All kinds of measuring equipment can be used as long as it satisfies the tolerances.*

**8.1.1.8.**

With respect to target butts and target faces:

**8.1.1.8.1.**

The butts shall provide a margin to allow all scoring arrows to be in the butt.

**8.1.1.8.2.**

At no point may any target face be less than 15cm from the ground.

**8.1.1.8.3.**

In all instances, regardless of the terrain, the buttress should be placed perpendicular to the athlete's line of sight from the shooting peg in order to present the target face's full picture.

**8.1.1.8.4**

At all times the full scoring zone shall be visible from a height of 150cm.

**8.1.1.9. UNIT FOR UNMARKED COURSE**

Number of targets 12 targets in a unit Min- Max #	Diameter of Field Faces (in cm)	Yellow Peg Barebow U18 Longbow* (in meters)	Blue Peg Recurve U18 Compound U18 Barebow Instinctive* (in meters)	Red Peg Recurve and Compound (in meters)
2-4	20	5 to 10	5 to 10	10 to 15
2-4	40	10 to 15	10 to 20	15 to 25
2-4	60	15 to 25	15 to 30	20 to 35
2-4	80	20 to 35	25 to 45	35 to 55

\* - Instinctive (WA Traditional)

**8.1.1.9.1.**

The distances of the targets faces of the same size should vary between long, medium and shot distances and it is recommended to use different sizes of buttresses.

**8.1.1.10. UNIT FOR MARKED COURSE**

Number of targets 12 targets in a unit Min- Max #	Diameter of Field Faces (in cm)	Yellow Peg Barebow U18 Longbow* (in meters)	Blue Peg Recurve U18 Compound U18 Barebow Instinctive* (in meters)	Red Peg Recurve and Compound (in meters)
3	20	5, 10, 15	5, 10, 15	10, 15, 20
3	40	10, 15, 20	15, 20, 25	20, 25, 30
3	60	20, 25, 30	30, 35, 40	35, 40, 45
3	80	30, 35, 40	40, 45, 50	50, 55, 60

\* - Instinctive (WA Traditional)

**8.1.1.10.1.**

The set distances may be adjusted with  $\pm 2m$  if needed, however the new measured distance shall be displayed on the peg. On marked rounds a double 60cm target face setup is recommended.

**8.1.1.11. ELIMINATION ROUNDS**

The Elimination Round consists of 6 marked targets per match. Each set of 6 targets will have a mix of all face sizes (20/40/60/80) and all distances will be pegged (short/medium/long). Organisers will lay the course with consideration to the venue, the terrain and the lay of the land.

**8.1.1.12. FINALS ROUNDS (AND TEAM QUARTER-FINALS)**

The semi final and final consist of four marked targets in each match with marked distances. During the finals the targets can be placed at the organiser wishes taking into consideration the terrain, lay of the



ground and venue. All target faces (20/40/60/80) must be used and there should be a mix of short, medium and long distances.

#### **8.1.1.12.1.**

*In the Mixed Team when shooting at 20cm face, each team will shoot at a 2x2 set up, one arrow in each.*

#### **8.1.1.13.**

*All targets shall be numbered in succession from 1 to 24. The numbers shall be clearly visible to archers and clearly identify the target number. They shall be placed 5-10m before reaching the shooting pegs for that target.*

#### **8.1.1.14.**

*The target numbers shall also function as the waiting area for the groups waiting for their turn to shoot. The members of the group shooting that target can be forward of the number board to assist with shading and spotting as necessary. From the waiting area it should be possible to see if anybody is standing at the peg.*

#### **8.1.1.15.**

*Clearly visible direction signs indicating the route from target to target shall be placed at adequate intervals to ensure safe and easy movement along the course.*

#### **8.1.1.16.**

*Suitable barriers shall be placed around the course, wherever necessary, to keep spectators at a safe distance while still giving them the best possible view of the competition. Only those persons having the proper accreditation shall be allowed on the course inside of the barriers.*

#### **8.1.1.17.**

*The assembly area should contain:*

- *A communication system allowing contact with the chairperson of the Tournament Judge Commission and the organisers;*
- *Adequate shelter for team officials;*
- *Separate shelter for the Jury of Appeal and the chairperson of the Judge Commission;*
- *Guarded shelter for the athletes gear and spare equipment;*
- *Practice targets on the competition days near the assembly point(s) for the athletes;*
- *Refreshment facilities;*
- *Toilets.*

#### **8.1.1.18.**

*The course(s) shall be completed and ready for inspection no later than 16 hours before the shooting starts. At World Championships they shall be ready along with details of any modifications to those courses for use as Elimination or Final Rounds, no later than the morning of two days before the shooting starts.*

## **8.2. VENUE EQUIPMENT AND SCORING ZONES**

### **8.2.1.**

The Field Face.

There are four field target faces:

- The 80cm face;
- The 60cm face;
- The 40cm face;
- The 20cm face.

Only those faces produced by a manufacturer licensed by World Archery shall be used at World Archery competitions.

**8.2.1.1.**

*Description.*

The face consists of a yellow centre spot and four equal scoring zones.

The yellow zone is divided into two scoring zones.

The inner ring is scored as 6 and the outer yellow zone as 5.

The two zones shall be divided by a black line of maximum 1mm in width. The rest of the face shall be black.

The four scoring zones shall be divided by white lines of maximum 1mm in width. There are no dividing lines between yellow and black.

Any dividing lines shall be in the higher scoring zones. The centre of the target face shall be indicated by a small "+" (cross). The lines of the cross shall not exceed 1mm in width and 4mm in length.

Drawing of the Field face see 1-6 Scoring Zones Target Face for Field.

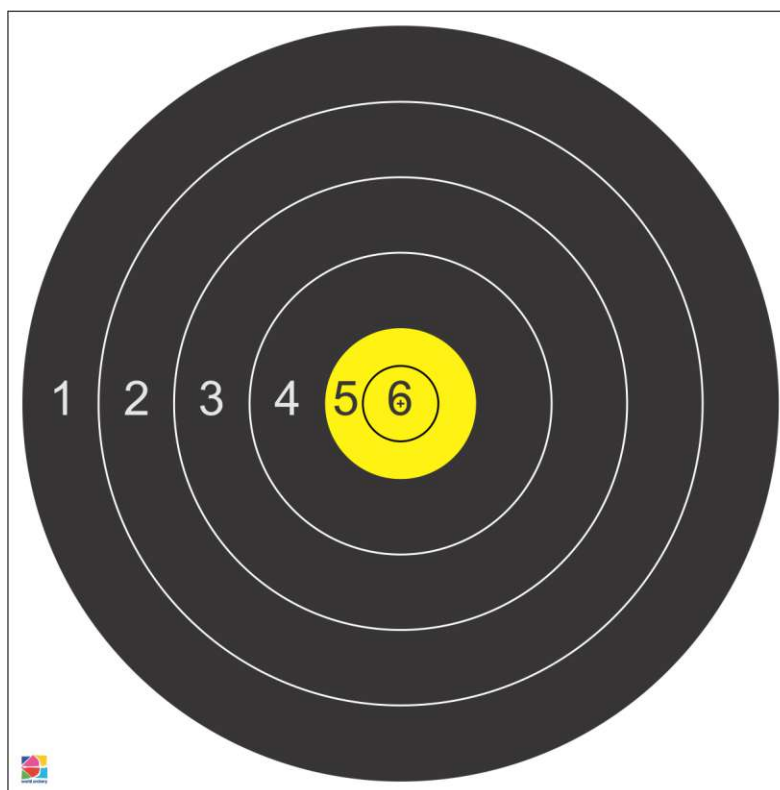

**Image 8:** 1-6 Scoring Zones Target Face for Field [\(AC version of Image\)](#)

**8.2.1.2.**

*Scoring Values, Colour Specifications and Tolerances.*

Diameter of faces and of scoring zones in cm						
Colour	Score	Diameter				Tolerance ± (mm)
		20	40	60	80	
Yellow	6	2	4	6	8	1
Yellow	5	4	8	12	16	1
Black	4	8	16	24	32	1
Black	3	12	24	36	48	2
Black	2	16	32	48	64	2
Black	1	20	40	60	80	2

**8.2.1.3.***Target set-up.*

- *The 20cm and 40cm faces may be placed at any angle provided it is still obvious which face or column the athlete is to shoot;*
- *20cm faces shall be 12 per butt in four columns of three;*
- *40cm faces shall be placed four per butt;*
- *60cm faces: On marked rounds a double 60cm target face setup is recommended and their centres should be positioned so that both archers have an equal shot.*

## CHAPTER 9 - FIELD OF PLAY SETUP - 3D ARCHERY

### 9.1. COURSE LAYOUT

#### 9.1.1.

The courses shall be arranged in such a way that the shooting positions and the targets can be reached without undue difficulty, hazard or waste of time. 3D courses shall be as condensed as possible.

##### 9.1.1.1.

*The walking distance from the central (assembly) area to the furthest target shall be no more than 1 kilometer or 15 minutes normal walking.*

##### 9.1.1.2.

*The course makers shall prepare safe paths for Judges, medical personnel and to allow for transportation of equipment through the course(s) while shooting is in progress.*

##### 9.1.1.3.

*The course(s) shall not be positioned higher than 1800m above sea level and the maximum difference between the highest and the lowest point in a course shall not be more than 100m.*

##### 9.1.1.4.

*The targets shall be laid out in such order as to take into consideration that there are unknown distances only, to allow maximum variety and best use of the terrain, with a fair balance between distance and size of the scoring zone.*

##### 9.1.1.5.

*For small targets, the organisers shall place two or four targets next to each other.*

##### 9.1.1.6.

*The targets shall be placed in a way as to present the full target to all athletes.*

##### 9.1.1.7.

*Shooting distances - unknown distances only:*

##### 9.1.1.7.1.

*Red pegs:*

- *Men and Women Compound Bow;*

*Maximum distance: 45m.*

*Minimum distance: 5m*

##### 9.1.1.7.2.

*Blue pegs:*

- *Men and Women Barebow;*
- *Men and Women Longbow;*
- *Men and Women Instinctive (WA Traditional) Bow;*

*Maximum distance: 30m.*

*Minimum distance: 5m*

##### 9.1.1.7.3.

*The 3D targets come in a range of sizes. The course must incorporate a range of target sizes placed at distances appropriate to their size.*

**9.1.1.8.**

All targets shall be numbered in succession from 1 to 24. The numbers shall be clearly visible to archers and clearly identify the target number. They shall be placed 5-10m before reaching the shooting pegs for that target.

**9.1.1.8.1.**

The target numbers shall also function as the waiting area for the groups waiting for their turn to shoot. The members of the group shooting that target can be forward of the number board to assist with shading and spotting as necessary. From the waiting area it should be possible to see if anybody is standing at the peg.

**9.1.1.9.**

When the shooting peg is free, the group can go forward to the post with the picture of the target – as the secondary waiting area until the target is free.

**9.1.1.10.**

Clearly visible direction signs indicating the route from target to target shall be placed at adequate intervals to ensure safe and easy movement along the course.

**9.1.1.11.**

Suitable barriers shall be placed around the course, wherever necessary, to keep spectators at a safe distance while still giving them the best possible view of the competition. Only those persons having the proper accreditation shall be allowed on the course inside of the barriers.

**9.1.1.12.**

The assembly area shall contain:

- A communication device (system) allowing contact between the Chairman of the Tournament Judge Commission, the Judge Commission, the Technical Delegate and the organisers;
- Adequate shelter for team officials;
- Separate shelter for the Jury of Appeal, the Chairman of the Tournament Judge Commission and the Technical Delegate;
- Guarded shelter for the athletes' gear and spare equipment;
- On the days of the tournament, some warm-up targets shall be set up near the Assembly Point(s) for the athletes;
- The practice field can be used as a warm-up field;
- Refreshment facilities;
- Toilets.
- 

**9.1.1.13.**

The 3D course(s) shall be completed and ready for inspection no later than 16 hours before the shooting starts. At Championships they shall be ready no later than the morning of two days before the shooting starts, except for modified courses.

**AC 9.1 COURSE LAYOUT – CANADIAN OUTDOOR 3D**

In general, the layout of a 3D course should follow the intent of the WA 3D layout [Section 9.1 Course Layout](#) with the following exceptions:

[AC Note: WA references to archers shooting in pairs left and right positions do not apply in Canadian 3D archery.]

**AC 9.1.1.5**

Small animal targets may be placed singly or in pairs. Archers shooting from the stake may shoot either animal.

**AC 9.1.1.6**

Animal targets shall be placed in a way as to present the full vitals scoring area to the archers. The placement may be quartered-off, and parts of the animal may be obscured by hazards, but the full vitals must be visible from the archer's position within 1 m of the stake (outdoors) or at the shooting position (indoors).

**AC 9.1.1.7**

Shooting distances:

- Orange stake- Maximum distance 50 yards:
  - Unlimited (Senior, 50+ U21);
  - Fixed Pins;
  - Known (Senior).
- Green Stake - Maximum distance 40 yards:
  - Unlimited (60+, U18);
  - Hunter.
- White Stake - Maximum distance 30 yards:
  - Known (U15, U13);
  - Barebow (Senior);
  - Instinctive <sup>(WA Traditional)</sup> (Senior);
  - Longbow (Senior);
  - Traditional (50+, U21, U18, U15, U13).

**9.2. VENUE EQUIPMENT AND SCORING ZONES****9.2.1.**

*The 3D Targets.*

*The courses are unmarked only. 3D Targets are used. The targets are three dimensional using a wide variety of forms of varying sizes. The number of targets used, their respective size and the size of the scoring zones are not standardised. The dividing lines of the scoring zones are within the higher scoring area.*

*The colour of the targets varies according to the target chosen.*

**9.2.2.**

*Scoring zones.*

*The target is divided into four scoring zones (11, 10, 8 and 5).*

*An arrow touching the dividing line between two scoring zones or the border line of the scoring area shall score the higher value.*

- *11 points the small circle in the centre of the 10 ring (about 25% of the 10-ring zone);*
- *10 points the larger circle within the vital area;*
- *Eight points vital area outside the 10-point circle;*
- *Five points remaining body colour zone;*
- *A hit in the horn or the hoof, or other defined non scoring area, not touching the body colour zone, a glance-off or any other miss counts as a miss (M). A hit in the tail or wings of a bird target is a scoring arrow. An arrow passing through the horn or hoof or other defined non scoring area, but touching a scoring zone, will score the value where it touches the scoring zone. An arrow passing through the horn or hoof or other defined non scoring area, but not touching a scoring zone will score a miss (M).*

**9.2.3.**

*Target pictures.*

*About 5-10m from the shooting peg, a post is placed showing the target picture of that target including the lines and the position of the respective scoring zones.*

**AC 9.2.3**

notwithstanding Article 9.2.3 ...

The pictures need to show only the outline of the vitals (8 zone).

**AC 9.2.3.1**

Pictures of the targets having multiple scoring zones shall show the vitals area to be scored.

**AC 9.3 RANGE LAYOUT – CANADIAN INDOOR 3D AC 9.3.0**

Indoor 3D courses are laid out in one or several indoor ranges in large indoor facilities (arenas, display halls, etc.) with an arrangement of 3D targets and artificial obstacles typically representing outdoor features (trees, straw bales, fences, culverts, etc.)

**AC 9.3.1.**

The ranges shall be arranged in such a way that the shooting positions are along a clearly defined shooting line from which all archers on a range will shoot in one direction only towards the targets. The shooting line shall be straight with no staggering.

**AC 9.3.2**

Shooting positions are usually grouped with 3 or 4 shooting positions in each group such that:

- Each shooting position is for one specific target;
- Athletes can shoot from each shooting position, rotating through the group of 3 or 4 shooting positions/targets during each end of shooting.

**AC 9.3.3.**

All targets and their corresponding shooting positions shall be numbered in succession, and the ranges will be labelled A, B, C, and D, or A, B and C.

- The numbers beside targets should be no less than 20cm tall.

**AC 9.3.4**

The shooting direction from each shooting position to the designated target should not cross any other shooting direction (i.e., no cross-shooting).

**AC 9.3.5**

The targets as described in [Article 9.2.1.](#) shall be laid out in such order as to take into consideration that there are unknown distances only to allow maximum variety and best use of the obstacles, with a fair balance between distance and size of the scoring zone.

- The courses should have a variety of large, medium and small targets, with a maximum of two targets smaller than a fox on any course.
- Small animal targets may be placed singly or in pairs. When targets are in pairs, an archer may shoot either animal.

**AC 9.3.6**

Animal targets shall be placed in a way as to present the full vitals scoring area to the archers. The placement may be quartered-off, and parts of the animal may be obscured by obstacles, but the full vitals must be visible within the reasonable movement of all archers while at the shooting position.

**AC 9.3.7**

Shooting distances:

Orange Line - Maximum distance 50 yards:

- Unlimited (Senior, 50+ U21);
- Unlimited (60+, U18);
- Fixed Pins;
- Known (Senior, U18);
- Hunter.

White Line - Maximum distance 30 yards:

- Known (U15, U13);
- Barebow (Senior);
- Instinctive <sup>(WA Traditional)</sup> (Senior);
- Longbow (Senior);
- Traditional (50+, U21, U18, U15, U13).

**AC 9.3.8**

Facilities should include both 3D ranges and at least one marked distance practice area.

**AC 9.3.9.**

Suitable barriers shall be placed around the ranges, wherever necessary, to prevent unauthorized entrance onto the range and keep spectators at a safe distance while still giving them the best possible view of the competition.

- Spectator viewing areas should be available at least 10 metres behind the shooting lines.

**AC 9.3.10**

Lights, Flags, Whistles or other sounding and communication devices must be available to control the shooting.

**AC 9.4 GRAND PRIX LAYOUT****AC 9.4.1**

The Grand Prix course shall be laid out:

**AC 9.4.1.1**

In a field, stadium or arena with suitable safety distance or barriers beyond the targets and around the range.

**AC 9.4.1.2**

Suitable barriers are placed around the course, wherever necessary, to keep spectators at a safe distance while still giving them the best possible view of the competition. Only those persons having the proper accreditation shall be allowed on the course inside of the barriers;

**AC 9.4.1.3**

The center or the 11 ring should be marked by the judges prior to the event.

**AC 9.4.1.4**

The DOS must have targets selected for the grand prix and the order they will be shot ready to present to the judges upon the course inspection prior to the first day of shooting so this can take place. Take note that you will need a total of at least 14 different targets plus spares for each shooting stake.

**AC 9.4.1.5**

Targets, as described in Article 9.2.1, shall be laid out in such order as to take into consideration that there are unknown distances only, to allow maximum variety and best use of the terrain or obstacles, with a fair balance between distance and size of the scoring zone;

**AC 9.4.1.6**

At least two stakes or defined shooting positions of each colour representing the shooting positions for each group;

**AC 9.4.1.7**

The targets shall be arranged at varying distances throughout the range such that several targets may be designated and shot from each stake;

**AC 9.4.1.8**

Any target may be designated for shots by a group, but in no case will targets farther than the maximum distance from a stake be designated;

**AC 9.4.1.9**

The Grand Prix area should contain:

- a communication system to regulate the matches and inform the participants and the spectators;
- a communication device (system) allowing contact between the Judge Commission, the Technical Delegate and the organisers;
- adequate shelter for participants and officials.



## CHAPTER 10 - SHOOTING CONTROL AND SAFETY IN TARGET ARCHERY

### 10.1.

A Director of Shooting shall be appointed.

#### 10.1.1.

*Whenever possible this shall be a Judge. The Director of Shooting shall not participate in the shooting.*

#### 10.1.2.

*Assistants may be appointed as necessary at the discretion of the organisers to assist the Director of Shooting in the execution of all the duties.*

### 10.2.

The Director of Shooting shall enforce any reasonable safety measures the Director of Shooting considers necessary. The duties include:

#### 10.2.1.

*Controlling the shooting, regulating the timing of ends, and the order in which the athletes shall occupy the shooting line.*

#### 10.2.2.

*Exercising control over the use of the audio equipment, the activities of photographers, and spectators so that athletes are not disturbed.*

#### 10.2.3.

*Ensuring that spectators remain behind the barriers enclosing the venue.*

#### 10.2.4.

*In the case of an emergency giving a series of not less than five sound signals for all shooting to cease. If shooting is suspended during an end for any reason, one sound signal shall be given for shooting to continue.*

#### 10.2.5.

*The Director of Shooting, in consultation with the Judges, has authority to extend the time limit in exceptional circumstances. Any such special ruling introduced shall be announced to the athletes before having effect. In such cases, the final results list shall include the special ruling and the reasons for it. When visual time controls are in use, the 30 seconds warning remains unchanged.*

#### 10.2.6.

*World Archery trained and appointed cameramen and photographers shall work within the spectator barriers described in [Article 7.1.1.10](#). Their position shall be determined by the Technical Delegate and the safety measures are under the responsibility of the Technical Delegate. They shall have a special World Archery uniform indicating that they have this right.*

### AC 10.2.6

Photographers, media personnel and V.I.P.s on the field of play, courses and practice areas shall escorted by a Judge or a designated official.

### AC 10.3 (new for 2024)

Pets are not allowed on the field of play at Target Archery, Field Archery and 3D Archery events.

#### AC 10.3.1 (new for 2024)

Service/support animals are allowed on the field of play with the following restrictions:

- The animal is secured and cannot interfere in the event;
- The animal is not allowed in the shooting line area while athletes are shooting.

## APPENDIX AC 3.1 - CANADIAN NATIONAL CHAMPIONSHIP ROTATION SCHEDULE

The Canadian Outdoor Target, Field and Outdoor 3D Championships are hosted according to a schedule ratified by the Archery Canada Board of Directors. This allows provinces time to confirm club(s) to host the championships on their behalf. The province is the host of the event and should work with the club for a successful event.

2024 NB	2025 AB	2026 ON	2027 MB	2028 QC
2029 NS	2030 SK	2031 PEI	2032 BC	2033 NB

## APPENDIX AC 3.2 - CANADIAN OUTDOOR TARGET CHAMPIONSHIP REGULATIONS

### 3.18.7.0

Canadian Championships shall not be held simultaneously with any other championship or tournament except:

#### AC 3.18.7.0.1

The Outdoor Target Championship and the Field Championship may be organized together such that there is a common schedule, but in no circumstances can the competition for any category be divided.

#### AC 3.18.7.1 Canadian Outdoor Target Championship

The format of the Canadian Outdoor Target Championship shall be:

- Official Practice and Equipment Inspection followed by the Fred Usher Cup (Day 1);
- Qualifications (Day 2):
  - One (1) individual 720 Qualification/Ranking Round:
    - ◆ As per [Articles AC 4.5.1.5 to AC 4.5.1.7](#) & Article 13.4., Book 3.
- Eliminations and Finals (Day 3):
  - Individual match play:
    - ◆ As per [Article AC 4.5.1.4.](#) & Article 13.4., Book 3.
  - No cut; all competitors advance to the Eliminations.
    - ◆ Eliminations/medal matches will only be held for categories with three (3) or more competitors.
    - ◆ Medals will be awarded based on the qualification round results in categories with fewer than three competitors.
- All Archery Canada equipment Divisions recognised for Outdoor Target Archery Championships apply;
- All Archery Canada age classes except U10 apply.

#### APP3.2.1 Events

The Canadian Outdoor Target Championships is held in conjunction with the following events:

- Canadian Outdoor Target Championships;
- Canadian Field Championships;
- Fred Usher Memorial Cup;
- Optional novelty shooting event:
  - Designed by the Organizing Committee and approved by the Archery Canada Executive.

#### APP3.2.2

Schedule of Events at the Canadian Outdoor Target Championships will be scheduled as agreed between the Archery Canada Executive and the Organizing Committee. In addition to the shooting events, the following will be scheduled:

- An optional novelty event;
- Social events;
- National Judge Clinic;
- Tournament Information Meeting(s);
- Equipment Inspection;
- Archery Canada Annual General Meeting;
- Board of Directors Meeting;
- Medal Presentations.

#### APP3.2.3 Registration

##### APP3.2.3.1

Separate registration fees will apply to the Outdoor Target Championship, the Fred Usher Cup, the Field Championship and any novelty events.

**APP3.2.3.2**

Registration fees will be set by the Organizing Committee and must be approved by the Archery Canada Executive.

**APP3.2.3.3**

The registration form will include a notice that a dress code is in effect at the Championship and that it will be enforced. Reference to where the dress code regulations can be found will be included on the registration form or will be included in the registration confirmation sent to registrants in advance of the Championship. If the Organizing Committee has a web site, the dress regulations will be posted.

**APP3.2.3.4 Guests**

(See Article 2.2.10, Book 1 re Guests)

Guests may register and shoot with competitors; however, Guests are not eligible for the Canadian Championship awards.

**APP3.2.3.4.1**

If Guests advance to the medal rounds, the Gold, Silver and Bronze medals will go to the top three Canadian participants.

**APP3.2.3.4.2**

When two (2) or more Guests advance to the medal rounds, the archers eliminated in the quarter-finals will shoot a one-arrow shoot-off to determine 5<sup>th</sup>, 6<sup>th</sup>, 7<sup>th</sup> and 8<sup>th</sup> places as per Book 3, Article 14.5.2.

**APP3.2.4.5 Coaches**

All coaches must register for the event (see [AC 3.7.3](#)).

**APP3.2.4.6 Agents**

While archer's agents do not have to pre-register for the event, they must obtain accreditations with their name and the archer's name for whom they are the agent on the accreditation and meet the dress code requirements.

**APP3.2.4 Officials****APP3.2.4.1**

A Director of Shooting will be appointed by the Organizing Committee with the agreement of the Technical Delegate.

**APP3.2.4.2**

Officials for receiving and posting of scores will be appointed by the Organizing Committee.

**APP3.2.4.3**

Archery Canada will appoint a Technical Delegate who will, together with other duties (ref [AC 3.5.4.1](#), Book 2):

- monitor results reporting and ensure that correct results are posted.

**APP3.2.4.4**

Archery Canada will appoint the Tournament Judge Commission.

**APP3.2.5 Team Officials**

Refer to AC 18 Team Officials – Canada, Book 3

**APP3.2.6 Practice**

See Book 3, Chapter 16, [Article AC 16.1.2](#).

**APP3.2.7 Program and Protocol****APP3.2.7.1**

The day before the Outdoor Target Championships begin, a Tournament Information Meeting will be held by the Judge Chairperson and a representative of the Organizing Committee for the purpose of conveying detailed information on the tournament and facilities and answering possible requests.

**APP3.2.7.2**

The day before the Outdoor Target Championships begin, the following take place:

- Official Practice in which athletes will be allowed to practice on the tournament field;
- Equipment inspection;
- Fred Usher Cup;

- Opening Ceremony, at which the competing teams march in, headed by their Team Captains and formed up in alphabetical order of province (according to the choice of language of the Organizers). The team from the host member association will be last. The procession will march past the stand for the officials and dignitaries. The President of the hosting provincial association or the appointed representative will then greet all present and introduce the President of Archery Canada, who will declare the Championships open. The teams then march out in the same order.

**APP3.2.7.3**

A reception (banquet or refreshments) will be organized during which prizes and trophies will be awarded.

**APP3.2.7.4**

When all medals have been awarded, the Archery Canada President or his delegate will thank the Organizers and athletes and declare the Championships closed.

**APP3.2.7.5**

Any change to the official schedule will be made only by a majority decision of the Team Captains.

**APP3.2.8 Target Assignments****APP3.2.8.1**

In the Qualification Round of the Outdoor Target Championships, athletes will be grouped alphabetically by last name within the category where this is feasible.

**APP3.2.8.2**

The Organizers may make alterations to the assignments to meet the constraints of field layout etc.

**APP3.2.8.3**

A list of athletes, according to target/group order and alphabetical order, must be distributed to all Officers, Judges, Athletes and Officials before the first day of the competition and each day during the competition.

**APP3.2.9 Venue, Equipment and Facilities****APP3.2.9.1**

The Field of Play shall be set up consistent with [Chapter 7](#).

**APP3.2.9.2**

The Organizing Committee will provide adequate shelter against the weather for athletes and their equipment.

**APP3.2.9.3**

Adequate toilet facilities for women, men, and wheelchairs will be provided within reasonable distance of the shooting field or along the ranges.

**APP3.2.9.4**

The Outdoor Target Championships may be held on an open field, in an open arena, or in a stadium.

**APP3.2.9.5**

Seating accommodations for all athletes and Team Officials will be made available close behind the waiting line. Sheltered seating will be provided for Judges at the waiting line.

**APP3.2.9.6**

The Director of Shooting will be positioned at a raised platform situated on the shooting line at the separation between parts of the field or on either end.

**APP3.2.10 Dignitaries and Media****APP3.2.10.1**

Dignitaries are Archery Canada Representatives, Sponsor Representatives, Archery Canada Board of Directors members, and others as designated by the Archery Canada Board of Directors or the Organizing Committee.

**APP3.2.10.2**

Dignitaries may enter the athlete area as long as a Judge escorts them.

**APP3.2.11 Dress Regulations**

Refer to Section 20, Book 3

### **APP3.2.12 Chaperones**

#### **APP3.2.12.1**

All U15 and U13 athletes must have a designated chaperone who is 19 or older and not competing in the event.

#### **APP3.2.12.2**

The Organizing Committee will assign chaperones to accompany youth groups on the Field of Play.

#### **APP3.2.12.3**

Chaperones are expected to assist the young athletes with tasks such as:

- Pulling arrows, finding arrows;
- Maintaining decorum during the competition;
- Assist with recording scores and totalling scorecards.

#### **APP3.2.12.4**

Chaperones will refrain from influencing any athlete while shooting or scoring and will wait in the athlete's area until shooting is completed.

## APPENDIX AC 3.3 - CANADIAN FIELD CHAMPIONSHIP REGULATIONS

### AC 3.18.7.2 Canadian Field Championship

The format of the Canadian Field Championship shall be:

- Qualifications:
  - Two Modified Field rounds:
    - ◆ One unmarked course of 12 targets or 1 unit, as per [Article 8.1.1.9](#). Unit for Unmarked Course;
    - ◆ One marked course of 12 targets or 1 unit, as per [Article 8.1.1.10](#). Unit for Marked Course;
  - Both rounds are shot on the same day.
- Eliminations:
  - Consists of individual match play as per [Articles AC 4.5.3.3.2 to AC 4.5.3.3.7](#).
- Finals:
  - Consists of the finals matches as per [Articles AC 4.5.3.3.8](#), [AC 4.5.3.3.8.1](#) and [4.5.3.3.8.2](#)
    - ◆ Finals matches will only be held for categories with three (3) or more competitors.
    - ◆ Medals will be awarded based on the qualification round results in categories with fewer than three competitors.
- All Archery Canada equipment Divisions recognised for Field Archery Championships apply except Excluded Divisions ([see Article AC 3.21](#));
- All Archery Canada age classes except U10 apply;
- Unless specified, the Canadian Field Championship is shot using World Archery Field Archery rules as found in Books 2 and 4.

### APP3.3.1 Events

The Canadian Field Championships is held in conjunction with the following events:

- Canadian Outdoor Target Championships;
- Fred Usher Memorial Cup;
- Optional novelty shooting event:
  - Designed by the Organizing Committee and approved by the Archery Canada Executive.

### APP3.3.2 Schedule of Events.

#### APP3.3.2.1

The Canadian Field Championship schedule may be varied according to the circumstances and with the approval of the Archery Canada Board of Directors.

- The Field Championship may be scheduled two days immediately before the Canadian Outdoor Target Championship.
- The Field Championship may be scheduled the day immediately after the Canadian Outdoor Target Championship.
- The Field Championship may be scheduled concurrently with the Outdoor Target Championship, whereby logical categories may be shooting Field while other categories may be shooting Target.

### APP3.3.3 Registration

#### APP3.3.3.1

Separate registration fees will apply to the Field Championship, the Outdoor Target Championship, the Fred Usher Cup and any novelty events.

#### APP3.3.3.2

Registration fees will be set by the Organizing Committee and must be approved by the Archery Canada Executive.

#### APP3.3.3.3

The registration form will include a notice that a dress code is in effect at the Championship and that it will be enforced. Reference to where the dress code regulations can be found will be included on the registration form or will be included in the registration confirmation sent to registrants in advance of the Championship. If the Organizing Committee has a web site, the dress regulations will be posted.

**APP3.3.3.4 Guests**

(See Article 2.2.10, Book 1 re Guests)

Guests may register and shoot with competitors; however, Guests are not eligible for the Canadian Championship awards.

**APP3.3.3.4.1**

If Guests advance to the medal rounds, the Gold, Silver and Bronze medals will go to the top three Canadian participants.

**APP3.3.3.4.2**

When two (2) or more Guests advance to the medal rounds, the second-place finishers from Pool A and Pool B will shoot a match to determine 5<sup>th</sup> and 6<sup>th</sup> place.

**APP3.3.4 Documents**

Ref [Article AC 3.9](#).

**APP3.3.5 Officials****APP3.3.5.1**

A Director of Shooting will be appointed by the Organizing Committee with the agreement of the Technical Delegate.

**APP3.3.5.2**

Officials for receiving and posting of scores will be appointed by the Organizing Committee.

**APP3.3.5.3**

Archery Canada will appoint a Technical Delegate who will, together with other duties (ref AC 3.5.4.1., Book 1):

- Monitor results reporting and ensure that correct results are posted.

**APP3.3.5.4**

Archery Canada will appoint the Tournament Judge Commission.

**APP3.3.5.4.1**

Judges appointed by Archery Canada in the same manner and concurrently with the Outdoor Target Championships (see [Article APP3.2.4.4](#)).

**APP3.3.5.4.2**

There will be at least 1 Judge for every 6 targets in the Field Championships.

**APP3.3.6 not used****APP3.3.7 Jury of Appeal**

Ref [Article AC 3.13](#).

**APP3.3.8 Team Officials****APP3.3.8.1**

Team Officials, unless competing, can only be in designated areas as follows:

- On the practice range;
- On the practice course;
- In the spectator areas of the competition course during the competition:
  - Unless otherwise required and accompanied by a Judge or official designated by a Judge.

**APP3.3.9 not used****APP3.3.10 Practice**

see Article 28.1, Book 4 and Article AC 28.1, Book 4.

**APP3.3.10.1**

For the Field Championships, practice will be allowed either on the tournament field course or on another field course nearby for at least one full day prior to the first day of competition and for at least two hours on the morning of the first day of competition if the competition begins after 12:00 noon. There must be warm-up butts available on a field course or practice range near the tournament field course, which may be used at least one hour before athletes must stop shooting before each day of competition.



### **APP3.3.11 Program and Protocol**

#### **APP3.3.11.1**

The day before the Field Championships begin, the following take place:

- Official Practice in which athletes will be allowed to practice on the practice range and the practice course;
- Equipment inspection;

#### **APP3.3.11.2**

Immediately before the Field Championships begin, a Briefing Meeting will be held by the Judge Chairperson and a representative of the Organizing Committee for the purpose of conveying detailed information on the tournament, the course and facilities and to answer possible requests.

#### **APP3.3.11.3**

Any change to the official schedule will be made only by a majority decision of the Team Captains.

### **APP3.3.12 Target Assignments**

#### **APP3.3.12.1**

Athletes will be grouped alphabetically by last name within category where this is feasible.

#### **APP3.3.12.2**

The Organizers may make alterations to the assignments to meet the constraints of course layout etc.

#### **APP3.3.12.3**

A list of athletes, according to target/group order and alphabetical order, must be distributed to all Officers and Judges and made available to Athletes and Officials before the practice day. Any revisions on the day of competition must also be made available.

### **APP3.3.13 Venue, Equipment and Facilities**

The Field course shall be set up consistent with [Chapter 8, Field of Play Setup - Field Archery](#).

#### **APP3.3.13.1** *(new 2020)*

There will be two (2) modified\* Field courses for Qualifications:

- One unmarked course of 12 targets or 1 unit, as per [Article 8.1.1.9. Unit for Unmarked Course](#);
- One marked course of 12 targets or 1 unit, as per [Article 8.1.1.10. Unit for Marked Course](#);
- shall be set up consistent with [Chapter 8, Field of Play Setup - Field Archery](#).

\* - 12 targets or 1 unit instead of the regular 24 targets or 2 units per course.

#### **APP3.3.13.2** *(new 2020)*

There will be a minimum of four (4) courses of six (6) targets for the Pool Shoot-Up Elimination Round.

- Each course will be set up according to [Article 8.1.1.11](#);
- The 24 targets from the two (2) qualification courses may split into four (4) courses of six (6) targets or new courses can be set up to accommodate spectators.

#### **APP3.3.13.3** *(new 2020)*

The finals venue will consist of four (4) targets set up according to [Article 8.1.1.12](#).

- The venue should allow for spectators.

#### **APP3.3.13.4** *(renumbered 2020)*

The Organizing Committee will provide adequate shelter against the weather for athletes and their equipment at the assembly area.

#### **APP3.3.13.5** *(renumbered 2020)*

Adequate toilet facilities for women and men (and wheelchairs when courses support the use of wheelchairs) will be provided within reasonable distance of the shooting field or along the courses.

#### **APP3.3.13.6** *(renumbered 2020)*

Some facilities for potable water should be provided on the courses.

**APP3.3.14 Dignitaries****APP3.3.14.1**

Dignitaries are Archery Canada Representatives, Sponsor Representatives, Archery Canada Board of Directors members, and others as designated by the Archery Canada Board of Directors or the Organizing Committee.

**APP3.3.14.2**

Dignitaries may enter the athlete areas as long as a Judge escorts them.

**APP3.3.15 Dress Regulations**

The following dress regulations apply to all participants (including Team Officials, coaches, assistants, etc.) while they are on the competition course, except when the regulations are relaxed due to inclement weather.

**APP3.3.15.1**

Participants must be neat in appearance with respect to personal grooming and clothing.

**APP3.3.15.2**

Clothing which is offensive, is in poor taste or is disrespectful to Archery Canada and its sponsors is not allowed.

**APP3.3.15.3**

Footwear covering the entire foot must be worn at all times while on the course.

**APP3.3.15.4**

The Technical Delegate will be responsible for enforcing the dress code and will make any decisions in connection with the appropriateness of dress or appearance.

**APP3.3.15.5**

Pants, shorts, skirts, divided skirts, etc., must be a solid un-patterned colour and may not be shorter than the fingertips when the arms and fingers are extended at the side.

- Blue jeans are permitted for the Field Championship
- Fleece track pants are not allowed

**APP3.3.15.6**

Men's and women's shirts must have sleeves and must cover the front and back of the body.

**APP3.3.15.7**

Not used.

**APP3.3.16 Chaperones****APP3.3.16.1**

All U15 and U13 athletes must have a designated chaperone who is 19 or older and not competing in the event.

**APP3.3.16.2**

The Organizing Committee will assign chaperones to accompany youth groups on the Field course.

**APP3.3.16.3**

Chaperones are expected to assist the young athletes with tasks such as:

- Pulling arrows, finding arrows;
- maintaining decorum during the competition;
- Assist with recording scores and totalling scorecards.

**APP3.3.16.4**

Chaperones will refrain from influencing any athlete while shooting or scoring and will wait behind the waiting area until shooting is completed.

**APP3.3.17 Spectators****APP3.3.17.1**

The Organizing Committee, in consultation with the Technical Delegate, shall determine how and where spectators may be present on the course(s).

**APP3.3.17.2**

Spectators must remain in the assigned waiting or defined spectator areas unless accompanied by a Judge or Safety Officer.

### **APP3.3.17.3**

Spectators must proceed only in the direction of the course unless guided by a Safety Officer.

### **APP3.3.17.4**

Spectators will refrain from providing any assistance to athletes or influencing any athlete while shooting or scoring.

## APPENDIX AC 3.4 - CANADIAN REGIONAL INDOOR TARGET CHAMPIONSHIP REGULATIONS

### AC 3.18.7.3

The format of the Canadian Regional Indoor Championship shall be:

- A single (1) indoor 18 Round;
- The competition is at various host sites across the country;
- All Archery Canada equipment Divisions recognised for Indoor Target Archery apply except Excluded Divisions (see Article AC 3.21);
- All Archery Canada age classes apply:
  - U10 events may be held at individual host sites, but no results will be posted and any awards are the responsibility of the Host Club.

### APP3.4.1 Events

The Canadian Regional Indoor Championship consists of two events shot concurrently

#### APP3.4.1.1

Individual Competition

#### APP3.4.1.2

Team Competition (club mixed team):

- A team will consist of three athletes, all of whom are members of the same club. An athlete may compete on only one team;
- All teams must have at least one member who is a U21, U18, U15, U13, Woman or Para-archer athlete and no team may have more than one 50+ or Senior shooting in the Compound, Compound Pins Fixed Compound or Unlimited, Divisions;
- A team's score will consist of the aggregate score, tens and nines of all its members attained in the individual competition;
- Athletes on the same team must shoot their scores on the same day at the same site.

### APP3.4.2 SCHEDULE

#### APP3.4.2.1

The Regional Indoor Championships are shot in various approved Host Site locations over the first consecutive Saturday and Sunday in March. Host Sites may run the event on one or both days.

In exceptional circumstances, the event may be held during the evening of the preceding Friday.

#### APP3.4.2.2

Host sites are not permitted to run the Archery Canada Regional Indoor Championship simultaneously with any other championship or tournament.

#### APP3.4.2.3

In the event that a site is unable to hold the competition due to severe and unavoidable events such as extreme weather or natural disasters, the Site Director may request an extension.

- The Indoors Coordinator, in consultation with the Archery Canada President, may grant an extension not to exceed seven days.
- In the case of such an extension, the deadlines for appeals and corrections will be extended correspondingly for athletes shooting at that site only.

#### APP3.4.2.4

The schedule for the event will be determined by the host club. The schedule will be posted on the AC Website as declared at the registration of the host site.

### APP3.4.3 Registration

#### APP3.4.3.1

Host Site Registration:

- Any club which is a member of an Archery Canada affiliated Provincial Association may apply to be a Host Site. A Provincial Association may notify Archery Canada that it wishes to designate clubs to host the

Championships; however, in the absence of such notification, all club applications will be accepted, provided they fulfil the requirements of a Host Site;

- Clubs wishing to be a Host Site will register with the Regional Indoors Coordinator by February 1 of the year of the Championships. The coordinator may refuse late registrations at his discretion;
- A site without a Provincial Judge officiating may enter as a "Non-Competitive" Host Site. The results of participants at Non-Competitive Sites will be listed along with the results from other Host Sites but they will be identified as "Non-Competitive" participants. Athletes participating at Non-Competitive Sites will not be eligible for medals, and the organizers at these Host Sites must make every effort to ensure that participants are aware of the Non-Competitive status of the Site.

#### **APP3.4.3.2**

##### Individual Registration

- Individual Athletes must register with the Host Site as prescribed by the Site Director.
- Athletes must declare their equipment division and age class on their scorecards, and Organizers will transfer this information to the registration form before shooting commences.
- No changes may be made to this registration information once shooting commences unless the athlete has been registered in a category for which he cannot legally register under Archery Canada rules.
- An athlete may register more than once at one or more Host Sites provided:
  - Separate registration fees are paid for each registration;
  - The athlete registers in a different equipment division each time;
  - The athlete registers in the same age class each time;
  - In the case of an athlete registering in the same equipment division more than once or in different age classes, his first score shot in a division or age class will count.
- In the event that the athlete registers at a site but does not submit a scorecard, his score will be entered as zero and will be considered the score for that athlete for the event
- An athlete who will be unable to attend one of the registered Host Sites and who will be competing in a tournament in another country or in a major tournament in Canada may apply in writing to the Indoor Coordinator before February 1 to have his score in that tournament entered for the Canadian Regional Indoor Championships provided that:
  - the athlete is otherwise eligible to shoot in the Regional Indoor Championships;
  - the 18 metre Indoor Round he will be shooting is registered with World Archery. [AC note: Archery Canada does not register events held outside of Canada with World Archery. This must be done by the World Archery Member Association in that country. Athletes wishing to shoot at an out-of-country site must ensure that the event has been properly registered with World Archery];
  - the round is held no more than seven days before the first regularly scheduled domestic Host Site shoots and no later than seven days after the last regularly scheduled domestic Host Site shoots;
  - a copy of the athlete's scorecard must be received by email, fax or mail by the Indoor Coordinator within three (3) days of the completion of the out-of-country round;
  - in the case of an event such as the Canada Games, which affects a number of athletes, the Regional Indoors Coordinator may grant permission to those athletes to use their scores without a written application from them individually.
- Provincial Games that are shot within a week before the event can be used as a site for the Archery Canada Regional Indoor Championship.

#### **APP3.4.3.3**

##### Team registration

- Teams must register with the Host Site as prescribed by the Site Director.
- A team must be formed and registered before any team member shoots a scoring arrow. The team registration must include each athlete's category (age, sex and equipment division), and only scores shot in that category may be used. If a team member's category has not been specified, the first score shot following the registration of the team will be used.
- A club may register any number of teams; however, only the highest-scoring team from a club will be eligible for awards.

**APP3.4.3.4**

## Fees – Host Site

- Archery Canada fees will be set from time to time at the discretion of the Archery Canada Executive.
- A late registration fee must be paid before a Host Site registration will be accepted after February 1.

**APP3.4.3.5**

## Fees – Competitors

- Site Organizers may charge reasonable fees for competitors at their discretion.

**APP3.4.3.6**

Guests may register and shoot with competitors; however, Guests are not eligible for awards.

**APP3.4.4 Officials****APP3.4.4.1**

Each Host Site will appoint a Site Director whose responsibilities will be as follows:

- Provide registration information for the site at least two (2) weeks prior to the event, including the names of the DOS and Judge;
- Arrange e-mail capability and spreadsheet software in order to submit results by the Monday noon following the site's shooting date;
- Correspond with the Regional Indoors Coordinator as required;
- post tournament results at the site or host clubhouse within two days of the results becoming available from the Regional Indoors Coordinator;
- Resolve queries and problems relating to an athlete's scorecards by referring to one original copy of the athlete's scorecard that will be retained by the site Organizers.

**APP3.4.4.2**

Each Host Site will appoint a Director of Shooting. The Director of Shooting may be one of the Judges. (See AC 2.2.10.5.1, Book 1 re Officials competing).

**APP3.4.4.3**

Each Host Site is responsible for ensuring that there will be at least one certified Provincial Judge officiating at a host site (Ref [Article AC3.11](#)); (See AC 2.2.10.5.1, Book 1 re Officials competing).

- A Host Site may apply for an exemption from the Provincial Judge status requirement for a particular Local Judge based on his competency. The decision regarding the exemption will be made by the Archery Canada Executive and the Chairman of the Judge Committee. Normally an exemption is granted only once for a given Judge.

**APP3.4.5 not used****APP3.4.6 Practice**

See Book 3, Chapter 16, [Article AC 16.1.2](#).

**APP3.4.6.2**

Where athletes may not initially have practice on their assigned butts, at least two ends during the practice period must be provided on the archer's assigned target position immediately before competition commences.

**APP3.4.7 Program and Protocol****APP3.4.7.1**

Program at each host site must include:

- Registration times
- Equipment Inspection time
- Practice times
- Competition times

**APP3.4.7.2**

As required, more than one flight may be shot at a host site: flighting must not interrupt each 60 arrow round;

- sufficient practice time must be allocated before each flight.

### **APP3.4.8 Target Assignments**

#### **APP3.4.8.1**

Shooting lines and target assignments/positions will be assigned at the discretion of the Organizers.

#### **APP3.4.8.2**

Athlete numbers are optional at the discretion of the Site Director.

### **APP3.4.9 Venue, Equipment and Facilities**

#### **APP3.4.9.1**

The tournament area will be arranged consistent with [Chapter 7 – Field of Play set-up – Target Rounds](#) as for an indoor tournament. There will be clearly divided areas between the:

- Shooting range;
- Spectators' area, which will be clearly defined by a barrier;
- Athletes' area;
- Media lane, if any.

#### **APP3.4.9.2**

The Organizing Committee will provide adequate heat, light and ventilation.

#### **APP3.4.9.3**

Smoking will not be allowed anywhere in the room(s) where shooting is taking place.

#### **APP3.4.9.4**

Adequate toilet facilities for women, men, and wheelchairs will be provided within reasonable distance of the shooting range.

#### **APP3.4.9.5**

The tournament will be held in an enclosed building.

#### **APP3.4.9.6**

Seating accommodations for all athletes, Team Officials and Judges will be made available close behind the waiting line.

#### **APP3.4.9.7**

The DOS will be positioned on the shooting line.

#### **APP3.4.9.8**

The Host Site will provide vertical or triangular 3-spot faces and single 40 cm faces for use at the option of each athlete. An athlete may not change face type (from 3-spot to 1-spot or vice versa) after his first scoring arrow.

### **APP3.4.10 Dignitaries and Media**

#### **APP3.4.10.1**

Dignitaries may enter the athlete area as long as a Judge escorts them. Dignitaries are Archery Canada Representatives, Sponsor Representatives, Archery Canada Board of Directors members, and others as designated by the Archery Canada Board of Directors or the Organizing Committee.

#### **APP3.4.11 Dress Regulations**

Refer to Section AC 20 Dress Regulations, Book 3

### **APP3.4.12 Chaperones**

#### **APP3.4.12.1**

Consideration must be given to provide knowledgeable chaperones to assist groups of young archers.

#### **APP3.4.12.2**

Chaperones are expected to assist the young athletes with tasks such as:

- Pulling arrows, finding arrows;
- Maintaining decorum during the competition;
- Assist with recording scores and totalling scorecards.

### **APP3.4.12.3**

Chaperones will refrain from influencing any athlete while shooting or scoring and will wait in the athletes' area until shooting is completed.

### **APP3.4.13 Documents**

#### **APP3.4.13.1**

The Regional Indoors Coordinator will ensure that the Regional Indoor information on the AC Website is updated in a timely fashion, including a reminder that a dress code is in effect and will be enforced.

#### **APP3.4.13.2**

The Regional Indoors Coordinator will maintain information regarding the event on the Archery Canada web site. The website will contain a reminder that a dress code is in effect and will be enforced.

#### **APP3.4.13.3**

All Host Sites will use a standard scorecard as provided with the Registration Package.

#### **APP3.4.13.4**

Scoring will be done on duplicate scorecards, both of which are to be signed by the athlete. Site Directors will confirm that the copies of the scorecards match and give one to the athlete and hold the other card until the deadline for corrections and appeals has passed, at which time the cards will be forwarded to the Archery Canada office.

#### **APP3.4.13.5**

An athlete must notify the Site Director of any reporting errors in his score within one week of the date the athlete's results are posted on the Archery Canada website. Within three (3) days of receiving notification of an error, the Site Director will notify the Regional Indoors Coordinator by fax or email, attaching a copy of the scorecard and an explanation of the reason for the change.

#### **APP3.4.13.6**

Host Site Directors must report results and provide other documents indicated in the host site information package.

##### **APP3.4.13.6.1**

The report must include the name of the Judge that officiated the event and the Judge Tournament Report.

### **APP3.4.14 Tie Breaking**

#### **APP3.4.14.1**

In the case of the Regional Indoor Championship, where it is not possible to hold shoot-offs, athletes or teams tied for medals will both be awarded the medal, and the next lower athlete or team will be ranked one place lower.



## APPENDIX AC 3.5 - CANADIAN OUTDOOR 3D CHAMPIONSHIP REGULATIONS

### AC 3.18.7.4 Canadian Outdoor 3D Championship

The format of the Canadian Outdoor 3D Championship shall be:

- Individual Qualifying Round according to [Article AC 4.5.7.0.2.1](#);
- Individual Finals Round according to [Article AC 4.5.7.0.2.3](#);
- Mixed Team Elimination Round according to [Article AC 4.5.7.0.3.2](#);
- Mixed Team Finals Round according to [Article AC 4.5.7.0.3.3](#);
- All Archery Canada equipment divisions recognized for 3D Archery Championships apply except Excluded Divisions ([see Article AC 3.21](#));
- All Archery Canada age classes apply:
  - U10 events may be held on a separate course, but no results will be posted, and any awards are the responsibility of the Host Club.

### APP3.5.1 Events

#### APP3.5.2 Schedule of Events

Except as approved by the Archery Canada Executive, the events will be scheduled as follows:

- Day 1, Friday:
  - Registration;
  - Equipment Inspection;
  - Practice;
  - Course Inspection;
- Day 2, Saturday:
  - Registration;
  - Equipment Inspection;
  - Opening Ceremonies;
  - Individual Round 1 (am);
  - Round 2 (pm).
- Day 3, Sunday:
  - Rounds 3 (am);
  - Mixed Team Event (pm);
  - Banquet and Entertainment.
- Day 4, Monday:
  - Finals Group A (am);
  - Finals Group B (pm);
  - Medal Presentations and Closing Ceremonies.

### APP3.5.3 Registration

#### APP3.5.3.1

Registration fees will be set by the Organizing Committee and must be approved by the Archery Canada Executive.

#### APP3.5.3.2 Guests

(See Article 2.2.10, Book 1 re Guests)

Guests may register and shoot with competitors; however, Guests are not eligible for the Canadian Championship awards.

#### APP3.5.3.2.1

If Guests advance to the medal rounds, the Gold, Silver and Bronze medals will go to the top three Canadian participants.

#### APP3.5.3.2.2

When more than two (2) Guests advance to the Finals rounds, the medals will go to the next highest scores from the qualification round.

### **APP3.5.4 Documents**

Ref section [Article AC 3.9](#)

#### **APP3.5.4.1**

in addition: The Organizers are responsible for producing the following documents:

- A list of the top 8 ranked archers from each stake and gender for selection of the entrants for the Shoot Up Finals event and the entrants to the Last Chance Qualifier.

### **APP3.5.5 Officials**

#### **APP3.5.5.1**

Safety Officers should be appointed, at least one per course and at least one for the practice range to monitor safety issues on the courses, assist archers and judges as needed and control shooting on the practice range.

#### **APP3.5.5.2**

Officials for receiving and posting of scores will be appointed by the Organizing Committee.

#### **APP3.5.5.3**

Archery Canada will appoint a Technical Delegate who will, together with other duties:

- Monitor results reporting and ensure that correct results are posted.
- Ensure that correct entrants to the Individual Finals, the Mixed Team Eliminations and Mixed Team Finals are selected and assigned to the correct groups.

#### **APP3.5.5.4**

Archery Canada will appoint the Tournament Judge Commission.

### **APP3.5.5.6 not used**

### **APP3.5.7 Jury of Appeal**

Ref [Article AC 3.13](#).

### **APP3.5.8 Team Officials**

#### **APP3.5.8.1**

Team Officials, unless competing, can only be in designated areas as follows:

- On the practice range;
- On the practice course;
- In the spectator areas of the competition course during the competition:
  - Unless otherwise required and accompanied by a Judge or official designated by a Judge.

### **APP3.5.9 not used**

### **APP3.5.10 Practice**

#### **APP3.5.10.1**

Practice areas outside of the championship courses will be open for practice on all four days of the event.

#### **APP3.5.10.2**

Practice is not allowed on any part of the 3D courses set out for competition.

#### **APP3.5.10.3**

The practice areas will include a measured distance target range and a 3D practice area.

### **APP3.5.11 Program and Protocol**

to be developed

### **APP3.5.12 Target Assignments**

#### **APP3.5.12.1**

First-round seeding shall be done by the Organising Committee such that:

- All categories are in groups with the same category;
- Any category is accommodated on one course only;

**APP3.5.12.2**

Group assignments on subsequent rounds on the final day of competition should be according to rank of the archers within the category.

**APP3.5.13 Venue, Equipment and Facilities****APP3.5.13.1**

The courses shall be set up consistent with [Chapter 9, Field of Play Setup - 3D Archery](#) and should have a variety of large, medium and small targets with a maximum of two targets smaller than a fox on any course.

**APP3.5.13.2**

Each target shooting station will be numbered for identification, and the courses will be labelled A and B. Each target will be numbered from 1 through 24.

**APP3.5.13.3**

If possible, a cloverleaf configuration should be used with the centre of the cloverleaf being the central area for the competition.

**APP3.5.13.4**

Trails should be laid out so that no competitors have to travel long distances to their first shooting position.

**APP3.5.13.5**

Indoor facilities will be required to host the required meetings, opening and closing ceremonies, banquet, and entertainment.

**APP3.5.13.6**

Outdoor facilities should include both 3D and marked butt practice areas, four (or 3) complete 3D courses, on-site camping, and parking.

**APP3.5.13.7**

The competition site should be close to the host hotel, airport and public transit if possible.

**APP3.5.13.8**

Provision of public washrooms for competitors' use during the event is essential. They can be provided at a central location, such as the registration area. It is also suggested that the possibility of portable washrooms be considered depending on the distance from the registration area while on the 3D courses.

**APP3.5.13.9**

Spectator viewing areas should be considered for a portion of the 3D courses and the Finals Shoot Up Round. The Finals Shoot Round event could take place inside an arena, if possible.

**APP3.5.13.10**

Medical services must be available on the grounds during the event.

**APP3.5.13.11**

The Canadian flag and the host province flag should be displayed at the event.

**APP3.5.13.12**

Bow racks must be provided near the practice areas and the central meeting area.

**APP3.5.13.13**

The Organizing Committee will provide adequate shelter against the weather for competitors and their equipment at strategic locations on the courses and near the central meeting area.

**APP3.5.13.14**

At least two chronographs and an adequate number of bow scales and arrow scales, provided by Archery Canada, to check competitors' equipment are required.

**APP3.5.13.15**

At the Opening Ceremonies, an area for the 3D Dignitaries will be provided. The 3D Dignitaries will include, but not be limited to, the President of the provincial hosting organization or his representative, the host club 3D Nationals Chairperson, the Archery Canada 3D Chairperson, and the President of Archery Canada or his representative.

**APP3.5.13.16**

Podiums at various levels for the successful competitors to stand while medals are being presented should be provided in an area where all participants can view the presentations.

**APP3.5.13.17**

Radios for communication of Judges and key officers of the Organizing Committee shall be provided by the OC.

**APP3.5.14 Dignitaries and Media****APP3.5.14.1**

Dignitaries are Archery Canada Representatives, Sponsor Representatives, Archery Canada Board of Directors members, and others as designated by the Archery Canada Board of Directors or the Organizing Committee.

**APP3.5.14.2**

Dignitaries may enter the athlete areas as long as a Judge escorts them.

**APP3.5.15 Dress Regulations****APP3.5.15.1**

General dress regulations apply.

**APP3.5.16 Chaperones****APP3.5.16.1**

All U15 and U13 athletes must have a designated chaperone who is 19 or older and not competing in the event.

**APP3.5.16.2**

The Organizing Committee will assign chaperones to accompany youth groups on the courses.

**APP3.5.16.3**

Chaperones are expected to assist the young athletes with tasks such as:

- Pulling arrows, finding arrows;
- Maintaining decorum during the competition;
- Assist with recording scores and totalling scorecards.

**APP3.5.16.4**

Chaperones will refrain from influencing any athlete while shooting or scoring and will wait behind the waiting area until shooting is completed.

**APP3.5.17 Spectators****APP3.5.17.1**

The Organizing Committee, in consultation with the Technical Delegate, shall determine how and where spectators may be present on the course(s).

**APP3.5.17.2**

Spectators must remain in the assigned waiting or defined spectator areas unless accompanied by a Judge or Safety Officer.

**APP3.5.17.3**

Spectators must proceed only in the direction of the course unless guided by a Safety Officer.

**APP3.5.17.4**

Spectators will refrain from providing any assistance to athletes or influencing any athlete while shooting or scoring.

## APPENDIX AC 3.6 - CANADIAN INDOOR 3D CHAMPIONSHIP REGULATIONS

### AC 3.18.7.4

The format of the Canadian Indoor 3D Championship shall be: Either:

- 4 courses of 20 3D targets, or
- 3 courses – one of 26 3D targets and two of 27 3D targets.
- All Archery Canada equipment divisions recognized for 3D Archery apply.
- All Archery Canada age classes apply,
  - U10 events may be held on a separate course.

### APP3.6.1 Events

The Canadian Indoor 3D Championship is shot in conjunction with the following events: 3D Grand Prix (see [Article AC 4.5.7.0.3](#))

### APP3.6.2 Schedule of Events

The schedule will be at the discretion of the host committee with approval by the Archery Canada Executive. Recommended the events will be scheduled as follows:

- Day 1, Saturday
  - Registration
  - Equipment Inspection
  - Opening
  - Round 1
  - Round 2
- Day 2, Sunday
  - Round 3
  - Round 4 (if 4 rounds total)
  - Grand Prix shoot-off
  - Medal Presentations and Closing Ceremonies

### APP3.6.3 Registration

#### APP3.6.3.1

Registration fees will be set by the Organizing Committee and must be approved by the Archery Canada Executive.

#### APP3.6.3.2

No registration fees will apply to the Grand Prix event.

#### APP3.6.3.3 Coaches

All coaches must register for the event (see [AC 3.7.3](#)).

### APP3.6.4 Documents

Ref [Article AC3.9](#)

#### APP3.6.4.1

in addition: The Organizers are responsible for producing the following documents:

- A list of the top 8 ranked archers from each stake and gender for selection of the entrants for the Grand Prix event.

### APP3.6.5 Officials

#### APP3.6.5.1

Safety Officers should be appointed by the Organizing Committee, at least one per course and at least one for each practice range to monitor safety issues on the courses, assist archers and judges as needed and to control shooting.

#### APP3.6.5.2

Officials for receiving and posting of scores will be appointed by the Organizing Committee.

**APP3.6.5.3**

Archery Canada will appoint a Technical Delegate who will, together with other duties:

- monitor results reporting and ensure that correct results are posted.
- Ensure that correct entrants to the Grand Prix event are selected and assigned to the correct groups.

**APP3.6.5.4**

Archery Canada will appoint the Tournament Judge Commission.

**APP3.6.6 Team Officials****APP3.6.6.1**

Team Officials, unless competing, can only be in designated areas as follows: on the practice range, on the practice course, in the spectator areas of the competition course during competition, unless otherwise required and accompanied by a Judge or official designated by a Judge.

**APP3.6.7 Practice****APP3.6.7.1**

Practice areas outside of the championship courses will be open for practice on all days of the event at times indicated by the Organizing Committee.

As practical, practice ranges should not be adjacent and within view of competition courses.

As necessary, shooting on adjacent practice ranges shall cease as archers on the competition courses move forward of the shooting line.

**APP3.6.7.2**

Practice is not allowed on any part of the 3D courses set out for competition.

**APP3.6.7.3**

The practice areas will include a measured distance target range.

**APP3.6.8 Program and Protocol**

to be developed

**APP3.6.9 Target Assignments****APP3.6.9.1**

First-round seeding shall be done by the Organising Committee such that:

- all categories are in groups with the same category;
- any category is accommodated on one course only.

**APP3.6.9.2**

Group assignments on subsequent rounds on the final day of competition should be according to the rank of the archers within the category.

**APP3.6.10 Venue, Equipment and Facilities****APP3.6.10.1**

The courses should have a variety of large, medium and small targets, with a maximum of two targets smaller than a fox on any course.

**APP3.6.10.2**

Each target shooting station will be numbered for identification, and the courses will be labelled A, B, C, and D, or A, B and C. Each target will be numbered from 1 through 20, 26 or 27, according to the number of targets on the course.

**APP3.6.10.3**

A shooting line from which all archers on a course will shoot must be clearly defined. The shooting line shall be straight with no staggering.

**APP3.6.10.4 not used****APP3.6.10.5**

Facilities will be required to host the required meetings, ceremonies, banquet, and entertainment.

**APP3.6.10.6**

Facilities should include both 3D and marked butt practice areas, four (or 3) complete 3D courses, washrooms, and parking.

**APP3.6.10.7**

The competition site should be close to the host hotel, airport and public transit if possible.

**APP3.6.10.8**

Provision of public washrooms for competitors' use during the event is essential.

**APP3.6.10.9**

Spectator viewing areas should be available at least 10 metres behind the shooting lines.

**APP3.6.10.10**

Medical services must be available on the grounds during the event.

**APP3.6.10.11**

The Canadian flag and the host province flag should be displayed at the event.

**APP3.6.10.12**

Bow racks must be provided near the courses and practice areas and the central meeting area.

**APP3.6.10.13 not used****APP3.6.10.14**

At least two chronographs and an adequate number of bow scales and arrow scales, provided by Archery Canada, to check competitors' equipment are required.

**APP3.6.10.15**

At the Opening Ceremonies, an area for the 3D Dignitaries will be provided.

**APP3.6.10.16**

Podiums at various levels for the successful competitors to stand while medals are being presented should be provided in an area where all participants can view the presentations.

**APP3.6.10.17**

Radios for communication of Judges and key officers of the Organizing Committee should be provide by the OC.

**APP3.6.11 Dignitaries and Media****APP3.6.11.1**

The Dignitaries will include, but not be limited to, the President of the provincial hosting organization or his representative, the host club 3D Nationals Chairperson, the Archery Canada 3D Chairperson, and the President of Archery Canada or his representative, other Archery Canada Representatives, Sponsor Representatives, Archery Canada Board of Directors members, and others as designated by the Archery Canada Board of Directors or the Organizing Committee.

**APP3.6.11.2**

Dignitaries may enter the athlete areas as long as a Judge escorts them.

**APP3.6.12 Dress Regulations****APP3.6.12.1**

General dress regulations apply.

**APP3.6.13 Chaperones****APP3.6.13.1**

All U15 and U13 athletes must have a designated chaperone who is 19 or older and not competing in the event.

**APP3.6.13.2**

The Organizing Committee may assign chaperones to accompany youth groups on the courses.

**APP3.6.13.3**

Chaperones are expected to assist the young athletes with tasks such as:

- Pulling arrows, finding arrows;

- Maintaining decorum during the competition;
- Assisting with recording scores and totalling scorecards.

### **APP3.6.14 Spectators**

#### **APP3.6.14.1**

The Organizing Committee, shall provide areas for spectators well back from shooting lines.

#### **APP3.6.14.2**

Spectators must remain in the assigned waiting or defined spectator areas unless accompanied by a Judge or Safety Officer.



## APPENDIX AC 3.7 - FRED USHER MEMORIAL CUP REGULATIONS

### AC 3.18.7.7 The Fred Usher Memorial Cup

The Fred Usher Memorial Cup is a mixed-team Championship for Provincial/Territorial and Individual Teams with the format:

- Round Robin Elimination Team Matches:
  - Sixteen teams in four pools;
- Semi-finals and Finals consisting of the winners of the four pools;
- Cash prizes for the 1<sup>st</sup>, 2<sup>nd</sup> and 3<sup>rd</sup> place.

#### AC 3.18.7.7.1

16 Team Format (with potential to increase);

- 1 team spot is held for each PTSO:
  - BC, AB, SK, MB, ON, QC, NB, NS, PE, YK and possibly NF and NWT;
  - PTSO spots are reserved until one month prior to the National Championships;
- The remaining 6 spots are open on a 'first come, first serve' basis to be composed of Individual Teams:
  - Teams may be predetermined at the time of registration or randomly assigned by the organizing committee.
    - ◆ Participants will be able to identify their preferences at the time of registration;
- All teams are composed of 3 archers from the following classes (U18, U21, Senior, 50+), divisions (Compound, Recurve and Barebow) and gender (Women and Men) and must include a minimum:
  - 1 Recurve or Barebow and 1 Women archer.

#### AC 3.18.7.7.2 - SHOOTING, TIMING & SCORING

Regardless of class or division, all teams will shoot from 50m on a full 80cm target face:

- Team Matches are shot according to Articles 13.2.2. & 13.2.3., Book3;
- No handicaps;
- Cumulative scoring.

#### AC 3.18.7.7.3 - ROUND ROBIN ELIMINATIONS

The elimination round will be a Round Robin format:

- 16 teams are put in 4 pools of 4 teams:
  - Teams are assigned to the pools by a random draw;

Pool A	Pool B	Pool C	Pool D
1 <sup>st</sup> drawn	2 <sup>nd</sup> drawn	3 <sup>rd</sup> drawn	4 <sup>th</sup> drawn
5 <sup>th</sup> drawn	6 <sup>th</sup> drawn	7 <sup>th</sup> drawn	8 <sup>th</sup> drawn
9 <sup>th</sup> drawn	10 <sup>th</sup> drawn	11 <sup>th</sup> drawn	12 <sup>th</sup> drawn
13 <sup>th</sup> drawn	14 <sup>th</sup> drawn	15 <sup>th</sup> drawn	16 <sup>th</sup> drawn

- teams drawn randomly.

- Each pool shoots a Round Robin format (3 matches):

Pool A		Pool B		Pool C		Pool D	
1 vs. 5	9 vs. 13	2 vs. 6	10 vs. 14	3 vs. 7	11 vs. 15	4 vs. 8	12 vs. 16
1 vs. 9	5 vs. 13	2 vs. 10	6 vs. 14	3 vs. 11	7 vs. 15	4 vs. 12	8 vs. 16
1 vs. 13	5 vs. 9	2 vs. 14	6 vs. 10	3 vs. 15	7 vs. 11	4 vs. 16	8 vs. 12

- 2 points for a win;
- 0 points for a loss;
- No ties in a match:
  - ◆ Ties in a match are broken by a shoot-off as laid out in [Article 14.5.2.3.](#), Book 3;
- All Round Robin matches will be shot simultaneously as laid out in [Article 13.2.2.](#), Book 3;
  - At the end of the Round Robin, ties in match points within a pool will be broken by a shoot-off as laid out in [Article 14.5.2.3.](#), Book 3.

**AC 3.18.7.7.4 - FINALS**

The Final rounds will consist of:

- The top team from each pool go into a semi-final grid;
  - 1<sup>st</sup> vs. 4<sup>th</sup>, 2<sup>nd</sup> vs. 3<sup>rd</sup> - based on the top team's average match scores of the 3 Round Robin Matches;
    - ◆ Ties in average match scores will be broken on the average number of 10s per match, followed by the average number of Xs.
  - Semi-final matches will be shot simultaneously according to [Article 13.2.2.](#), Book 3;
    - ◆ Ties in a match are broken by a shoot-off as laid out in [Article 14.5.2.3.](#), Book 3;
- Match winners go into the Gold/Silver finals match. Match losers go into the Bronze finals match;
  - If time permits, the Gold/Silver and Bronze final matches will be shot using the alternate shooting format according to [Article 13.2.3.](#), Book 3.

**AC 3.18.7.7.5 - PURSE** (new 2020)

The purse is based on the registration fee per team, see [Article APP3.7.3.2](#), times the total number of teams registered:

- Total purse (based on 16 teams) is \$3200:
  - 1<sup>st</sup> \$1500 or 15/32<sup>nd</sup> of total purse;
  - 2<sup>nd</sup> \$900 or 9/32<sup>nd</sup> of total purse;
  - 3<sup>rd</sup> \$600 or 6/32<sup>nd</sup> of total purse;
- Cash prizes to be awarded at the time of the medals.

**APP3.7.0 General Procedures**

- Matches are shot in 4 ends of 6 arrows per team.
- All matches at each stage are shot simultaneously with each team on its own target, except:
  - the final match shall be team alternate shooting if permitted by event timing.
- Scoring takes place after every end.
  - During the Round Robin Eliminations, each team will go to the targets to score.
  - During the Semi-Finals and Finals, each team will appoint an agent who will verify the arrow scores as called and recorded by a judge assigned to each pair of targets. The agent will withdraw the team's arrows and return them to the shooting line after the second end.
- Runners will return the scorecard for each match to the Results Official as soon as possible after each end.
- Blinds may be used for the judges, agents and runners to speed up the process.
- A tie is broken according to the normal Olympic Round Team Elimination Round team match play rules, except that one-half of the team's per-end bonus points (ignoring fractional points) will be added to the three-arrow score shot in tie-breaking ends.

**APP3.7.1 Events**

The Fred Usher Memorial Cup is a provincial team championship which is held in conjunction with the following events:

- Canadian Outdoor Target Championships;
- Canadian Field Championships;
- Optional novelty shooting event

**APP3.7.2 Schedule of Events**

The Fred Usher Memorial Cup provincial team championship will be scheduled during the Canadian Outdoor Target Championship as agreed between the Archery Canada Executive and the Organizing Committee. The event is commonly scheduled the day before the 720 Round.

**APP3.7.3 Registration****APP3.7.3.1**

A Province or Territory may enter only 1 team:

- Team members must be Archery Canada members in good standing residing in that province or territory.
- Individual teams may have members from different Provinces or Territories.

**APP3.7.3.2**

Each team pays \$200 to register or \$70 per person when registering individually.

**APP3.7.3.3**

Registration for the Fred Usher Memorial Cup is at the same time as individual registration:

- Spots are reserved for the PSO/TSOs until one month prior to the National Championships;
- The remaining spots are allocated on a first-come, first serve basis to Individual Teams, which may be predetermined at the time of registration or randomly assigned by the organizing committee. Participants will be able to identify their preferences at the time of registration.

**APP3.7.3.4**

Teams of guests may not participate in the Fred Usher Memorial Cup event.

**APP3.7.4 Documents****APP3.7.4.1**

The Organizers are responsible for producing the following documents:

- Match play charts in large format for the posting of matches and scores;
- Team scorecards have places for three (3) Round Robin Matches and two (2) finals matches.

**APP3.7.5 Officials****APP3.7.5.1**

The Director of Shooting for the Outdoor Target Championship will control shooting.

**APP3.7.5.2**

Officials for receiving and posting of scores will be appointed by the Organizing Committee.

**APP3.7.5.3**

The Technical Delegate will monitor score reporting and ensure that correct matches are posted.

**APP3.7.5.4**

Scorers appointed by the Organizing Committee may be required

**APP3.7.5.5**

Judges appointed by Archery Canada will control the Fred Usher Memorial Cup event. These will normally be the judges officiating at the Outdoor Target Championship.

- Eight (8) judges will be required for the Round Robin Elimination matches.

**APP3.7.6 not used****APP3.7.7 Jury of Appeal**

Ref [Article AC 3.13](#).

**APP3.7.8 Team Officials****APP3.7.8.1**

Regulations for the Canadian Outdoor Target Championship apply.

**APP3.7.8.2**

One Team Official to act as Coach may enter the area designated for each team and must remain in the designated area for the coach (Coach box).

**APP3.7.8.3**

For the semi-final and final matches an agent for each team will be required to represent the team at the targets and to retrieve arrows for the team.

**APP3.7.9 Athlete Numbers**

See [Article APP3.7.15](#) regarding team identification.

**APP3.7.10 Practice****APP3.7.10.1**

Practice on the competition field shall be scheduled immediately before the team competition. The duration of the practice will be determined by the Technical Delegate.

**APP3.7.10.2**

Judges will be available to assist and monitor team procedures, indicating violations and warnings applicable to team competition.

**APP3.7.11 Program and Protocol**

to be developed

**APP3.7.12 Target Assignments****APP3.7.12.1**

First-round seeding in the Round Robin eliminations will be done based on the draw for the four pools.

**APP3.7.12.2**

Subsequent target assignments will be posted on the match play chart.

**APP3.7.13 Venue, Equipment and Facilities****APP3.7.13.1**

The Field of Play shall be set up for team match play consistent with [Chapter 7 Field of Play Setup - Target Rounds](#) and particularly section [Article 7.1.1.13](#) & [Article 7.1.1.14](#).

**APP3.7.13.2**

Targets shall be arranged one buttress per team, with teams in the same match on adjacent targets and with one empty lane between matches.

**APP3.7.13.3**

A leaderboard to display matches, target assignments and ongoing results will be provided by the Organizing Committee.

**APP3.7.14 Dignitaries and Media****APP3.7.14.1**

Regulations of the Canadian Outdoor Target Championship apply.

**APP3.7.15 Dress Regulations****APP3.7.15.1**

Dress regulations of the Outdoor Target Championships apply.

**APP3.7.15.2**

All provincial team members, including coaches on the field of play shall wear uniform dress distinctive for their provincial team.

**APP3.7.15.3** *(new 2020)*

Individual Teams, dress regulations of the Outdoor Target Championships apply.

**APP3.7.16 Chaperones**

Not applicable.

**APP3.7.17 Spectators**

to be developed

## APPENDIX AC 3.9 - INDOOR MAIL MATCH REGULATIONS

### AC 3.18.7.8

The Mail Match is a multi-site indoor competition over a long duration with the formats:

- A series of Canadian 300 rounds shot at multiple club locations
  - The results are submitted weekly, and
  - The average of the best 6 scores for each competitor or team is used to determine awards.
- There are three events:
  - Individual event by category - athletes compete in all recognized divisions for medals;
  - Individual event by mail match class - athletes compete for awards in each Mail Match class within an assigned Mail Match class based solely on the score achieved regardless of equipment division, age or sex. A total of 7 Gold Medals are available to be won.;
  - Club Team event – athletes participate in teams with mixed categories for team medals.

### AC 3.18.7.8.1

All Archery Canada equipment divisions recognized for Target Archery and all Archery Canada age classes except U10 apply.

### AC 3.18.7.8.2

Team composition shall consist of: at least one (1) finger shooter, at least one (1) release shooter and at least one (1) woman, U21 or younger age or para-archer.

### APP3.9.1 Events

#### APP3.9.1.1

The three events that can be shot concurrently (ref AC 3.18.7.7 above).

#### APP3.9.1.2

An athlete may compete:

- In any number of shooting divisions, provided they submit the required fee for each separate division entered:
- In only one age class, [Article 4.2.2.1](#).

#### APP3.9.1.3

Each athlete will be assigned a classification based on his score in the Mail Match in the previous year as follows:

Compound	All Other Divisions
Class A (285-300)	560 Club (280-300)
Class B (280-284)	Expert A (255-279)
Class C (265-279)	Expert B (230-254.)
Class D (250-264)	Bowman (205-229)
Class E (200-249)	Archer (175-204)
Class F (150-199)	Yeoman (125-174)
Class G ( 0-149)	Tyro (0-124)

#### APP3.9.1.3.1

Any athlete who did not compete in the previous year's Mail Match will compete as "Unclassified" and will be classified for awards based on his score for the current year. Athletes who receive a classification in the Mail Match must compete in that class the following year. A major change in the physical condition of the athlete may be grounds for a downward reclassification. Application for reclassification must be made to the Mail Match Coordinator who has complete authority for such reclassification.

#### APP3.9.1.4 Club Team Mail Match Event

##### APP3.9.1.4.1

A team will consist of 3 or 4 members from the same club.

##### APP3.9.1.4.2

The team member names must be mailed to the Mail Match Coordinator with the first team score.

**APP3.9.1.4.3**

No substitutions are allowed. The team members may not change after the first score is submitted.

**APP3.18.1.4.4**

Team composition will be:

- At least one (1) finger shooter;
- At least one (1) release shooter;
- At least one (1) Woman, U21, U18, U15, U13 or Para-archer athlete.

**APP3.9.1.4.5**

A club may only enter one team.

**APP3.9.1.4.6**

A team score consisting of the total of any of the three team members' scores for a Canadian 300 Round may be submitted each full calendar week (Monday through Sunday) provided:

- All of six scores must be submitted for a team to be eligible for medals.

**APP3.9.2 Schedule of Events****APP3.9.2.1**

The Mail Match event commences on 01 January and must be completed by 30 March of each year.

**APP3.9.2.2**

Any schedule for shooting may be defined by the host Club.

**APP3.9.3 Registration****APP3.9.3.0**

In order to host the Indoor Mail Match, a host club must be an Archery Canada affiliated club.

- Exceptions are made for extenuating circumstances (e.g., athletes attending post-secondary school in the United States).

**APP3.9.3.1**

Participants will register through the Archery Canada registration system and notify their club coordinator of their registration.

**APP3.9.3.2**

The Club Mail Match Secretary will register with the AC Mail Match Coordinator with the first submission of scores.

**APP3.9.3.3 Fees**

There will be a fee for each athlete in the Individual Event as set from time to time by Archery Canada.

**APP3.9.3.3.1**

The fee will be paid online at the time of registration.

**APP3.9.3.3.2**

For those not able to pay online, the fee will be collected by the Mail Match Secretary.

The Mail Match Secretary will submit the fee to the AC Mail Match Coordinator before the first score from that athlete is submitted.

**APP3.9.4 Documents****APP3.9.4.1**

Scores shall be submitted by the Club Mail Match Secretary in the form prescribed by the AC Mail Match Coordinator.

**APP3.9.4.2**

The Mail Match Chairman will publish monthly updates of scores and averages.

**APP3.9.5 Score Submission**

The Mail Match Secretary will be responsible for submitting scores to the Archery Canada Mail Match Coordinator.

**APP3.9.18.1**

One Canadian 300 Round (30 arrows) score may be submitted per athlete per full calendar week (Monday - Sunday).

- Only one Mail Match Canadian 300 Round may be shot (attempted) in any calendar week (see APP3.9.9.1).

**APP3.9.5.2**

A minimum of 6 scores must be submitted for an athlete to be eligible for medals.

**APP3.9.5.3**

The Club's Mail Match Secretary must submit scores to the Archery Canada Mail Match Coordinator by email within one (1) week after the day they are shot, but in any case, no later than April 30 of the current year.

**APP3.9.6 Officials****APP3.9.6.1**

A Mail Match Secretary will be appointed by an Archery Canada club participating in the Mail Match.

**APP3.9.6.2**

Judges - Each Mail Match will be supervised by a Local or higher judge or the Mail Match Secretary except by permission of the Mail Match Coordinator.

**APP3.9.7 Team Officials**

Not applicable

**APP3.9.8 Practice****APP3.9.9 Program and Protocol****APP3.9.9.1**

Declaration of Round - Athletes and Teams must declare to the club's Mail Match Secretary or Local Judge that a round is being shot for the Mail Match before the first arrow of the round is shot.

**APP3.9.9.1.1**

With the agreement of the club Mail Match Secretary, a Mail Match Round may be shot at another club as long as the round is pre-declared with the Mail Match Secretary and all other Mail Match rules are met.

**APP3.9.10 Target Assignments**

Target assignments are at the discretion of the Host Club.

**APP3.9.11 Venue, Equipment and Facilities**

The venue, facilities, and equipment shall be as required for indoor target archery described in [Book 2, Chapter 7, Field of Play Setup - Target Archery](#).

**APP3.9.12 Dignitaries**

Not applicable.

**APP3.9.13 Dress Regulations**

The standards of dress may be established by the host club.

**APP3.9.14 Awards****APP3.9.14.1**

At the end of the competition, the six best scores for each athlete are averaged and medals awarded in each division and classification.

**APP3.9.14.1**

In the case of the Mail Match, where it is not possible to hold shoot-offs, athletes or teams tied for medals will both be awarded the medal, and the next lower athlete or team will be ranked one place lower.

**APP3.9.14.2**

Six-for-Sixty Pins are also awarded for athletes who score 60 points in two consecutive ends. Athletes are charged for these pins.

## APPENDIX AC 3.10 - OUTDOOR MAIL MATCH REGULATIONS

### AC 3.18.7.9

The Outdoor Mail Match is a multi-site outdoor competition over a long duration with the formats:

- A series of 720 rounds shot at multiple club locations:
  - The results are submitted weekly, and
  - The average of the best 6 scores for each competitor or team are used to determine awards.
- There are two events shot concurrently:
  - Individual event by category - athletes compete in all recognized divisions for medals;
  - Individual event by mail match class - athletes compete for awards in each mail match class within an assigned mail match class based solely on the score achieved regardless of equipment division, age or sex. A total of 7 Gold Medals are available to be won;

### AC 3.18.7.9.1

All Archery Canada equipment divisions recognized for Outdoor Target Archery and all Archery Canada age classes except U10 apply.

### APP3.10.1 Events

#### APP3.10.1.1

The two events can be shot concurrently (ref AC 3.18.7.9 above).

#### APP3.10.1.2

An athlete may compete:

- In any number of shooting divisions provided, he submits the required fee for each separate division entered:
- In only one age class, [Article 4.2.2.1](#).

#### APP3.10.1.3

Each athlete will be assigned a classification based on his score in the Mail Match in the previous year as follows:

All Divisions	Scores
700 Club	700- 720
Expert A	621 - 699
Expert B	550 – 620
Bowman	400 – 549
Archer	250 – 399
Yeoman	150 – 249
Tyro	0 - 149

#### APP3.10.1.3.1

Any athlete who did not compete in the previous year's Mail Match will compete as "Unclassified" and will be classified for awards based on his score for the current year. Athletes who receive a classification in the Mail Match must compete in that class the following year. A major change in the physical condition of the athlete may be grounds for a downward reclassification. Application for reclassification must be made to the Mail Match Coordinator, who has complete authority for such reclassification.

#### APP3.10.1.4 not used.

### APP3.10.2 Schedule of Events

#### APP3.10.2.1

The Mail Match event commences on 01 June and must be completed by 30 September of each year.

#### APP3.10.2.2

Any schedule for shooting may be defined by the host Club.



### **APP3.10.3 Registration**

#### **APP3.10.3.0**

In order to host the Outdoor Mail Match, a host club must be an Archery Canada affiliated club.

- Exceptions are made for extenuating circumstances (e.g., athletes attending post-secondary school in the United States).

#### **APP3.10.3.1**

Participants will register through the Archery Canada registration system and notify their club coordinator of their registration.

#### **APP3.10.3.2**

The Club Mail Match Secretary will register with the AC Mail Match Coordinator with the first submission of scores no later than July 15th of the calendar year. Confirmation of payment to Archery Canada is required prior to official entry into the competition.

#### **APP3.10.3.3**

Fees - There will be a fee for each athlete in the Individual Event as set from time to time by Archery Canada.

#### **APP3.10.3.4**

The Club Mail Match Secretary will submit to the AC Mail Match Coordinator National Office the required fee for each athlete no later than July 15, along with the first score from that athlete, or a late fee (\$25) will be applied.

### **APP3.10.4 Documents**

#### **APP3.10.4.1**

Scores shall be submitted by the Club Mail Match Secretary in the form prescribed by the AC Mail Match Coordinator.

#### **APP3.10.4.2**

The Mail Match Chairman will publish monthly updates of scores and averages.

### **APP3.10.5 Score Submission**

The club Mail Match Secretary will be responsible for submitting scores to the Archery Canada Mail Match Coordinator.

#### **APP3.10.5.1**

One 720 Round (72 arrows) score may be submitted per athlete per full calendar week (Monday - Sunday).

- Only one Mail Match 720 Round may be shot (attempted) in any calendar week (see APP3.10.9.1).

#### **APP3.10.5.2**

A minimum of 6 scores must be submitted for an athlete to be eligible for medals.

#### **APP3.10.5.3**

The Club's Mail Match Secretary must submit scores to the Archery Canada Mail Match Coordinator by email within one (1) week after the day they are shot, but in any case, no later than October 30 of the current year.

### **APP3.10.6 Officials**

#### **APP3.10.6.1**

A Mail Match Secretary will be appointed by an Archery Canada club participating in the Mail Match.

#### **APP3.10.6.2**

Judges - Each Mail Match will be supervised by a Local or higher judge or the Mail Match Secretary except by permission of the Mail Match Coordinator.

### **APP3.10.7 not used**

### **APP3.10.8 Practice**

to be developed

### **APP3.10.9 Program and Protocol**

### **APP3.10.9.1**

Declaration of Round - Athletes must declare to the club's Mail Match Secretary or Local Judge that a round is being shot for the Mail Match before the first arrow of the round is shot.

#### **APP3.10.9.1.1**

With the agreement of the club Mail Match Secretary, a Mail Match Round may be shot at another club as long as the round is pre-declared with the Mail Match Secretary and all other Mail Match rules are met.

### **APP3.10.10 Target Assignments**

Target assignments are at the discretion of the Host Club.

### **APP3.10.11 Venue, Equipment and Facilities**

The venue, facilities, and equipment shall be as required for outdoor target archery described in [Book 2, Chapter 7 Field of Play Setup - Target Archery](#).

### **APP3.10.12 Dignitaries**

Not applicable.

### **APP3.10.13 Dress Regulations**

The standards of dress may be established by the host club.

### **APP3.10.14 Awards**

#### **APP3.10.14.1**

At the end of the competition, the six best scores for each athlete are averaged and medals awarded in each division and classification. (See [Article AC 6.2.4](#) re medals)

#### **APP3.10.14.1**

In the case of the Mail Match, where it is not possible to hold shoot-offs, athletes tied for medals will both be awarded the medal, and the next lower athlete will be ranked one place lower.

#### **APP3.10.14.2**

Six-for-Sixty Pins are also awarded for athletes who score 60 points in one end. Athletes are charged for these pins.

## APPENDIX AC 3.11 - CANADIAN CUP EAST & WEST REGULATIONS

### APP3.11.1 Event

The Canadian Cup East and West are major annual target archery events held in Eastern Canada and Western Canada, respectively:

- Canada Cup East is held in one of the following provinces:
  - New Brunswick
  - Nova Scotia
  - Ontario
  - Prince Edward Island
  - Quebec
- Canada Cup West is held in one of the following provinces:
  - Alberta
  - British Columbia
  - Manitoba
  - Saskatchewan
  - Yukon

### APP3.11.2

The schedule of Events at the Canada Cup East and West will be scheduled as agreed upon between the Organizing Committee and the Archery Canada Events Committee.

- The events will be held before the Outdoor Canadian Championships, preferably in the month of June, over three days on a weekend.
- The Canada Cup East and Canada Cup West will not be held on the same weekends.

### APP3.11.3

The format of the Canada Cups will be:

- Day 1 (Friday):
  - am – Official Practice and equipment inspection;
  - pm – Official Practice and equipment inspection;
  - pm – optional 720 round (does not count towards ranking for eliminations).
- Day 2 (Saturday):
  - am – 720 Ranking Round;
  - pm – Mixed Team Round.
- Day 3 (Sunday):
  - Individual Elimination and Medal Match Rounds:
    - ◆ No cut, all competitors advance to the Eliminations:
      - Eliminations/medal matches will only be held for categories with three (3) or more competitors;
      - In categories with less than three competitors, medals will be awarded based on the qualification round results.
      - Where appropriate, categories may be combined.
    - ◆ All match rounds are shot simultaneously;
    - ◆ Matches will be single elimination:
      - Canadian Double Eliminations are optional if the schedule permits.
  - Medal Presentations.
- All Archery Canada equipment Divisions recognised for Outdoor Target Archery apply.
- All Archery Canada age classes except U10, U13 and U15 apply

### APP3.11.3

The format of the Mixed Team Round will be:

- A minimum of four (4) and a maximum of eight (8) Compound Mixed Teams;
- A minimum of four (4) and a maximum of eight (8) Recurve Mixed Teams;
- Only senior distances will be shot:
  - 50 m for compound;

- 70 m for recurve.
- All age class can register, U18, U21, Senior and 50+;
- Teams will be ranked based on the teams' individual 720 Round total scores.

**Match Play Chart: 8 Teams (Byes are Permitted)**

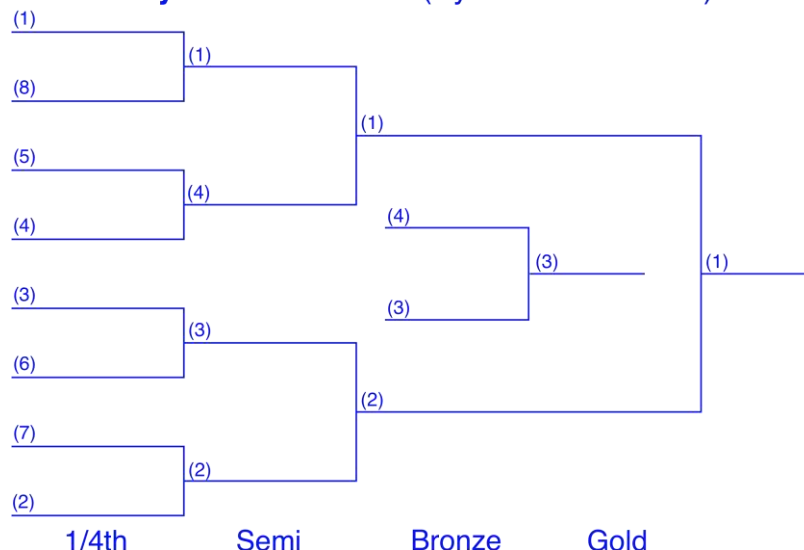

**APP3.11.4 Registration**

**APP3.11.4.1**

At the discretion of the Organisers, separate registration fees may apply to the Mixed Team round and the Optional 720 round.

**APP3.11.4.2**

Registration fees will be set by the Organizing Committee and must be approved by the Archery Canada Executive.

**APP3.11.4.3**

The registration form will include a notice that a dress code is in effect at the Event and that it will be enforced. Reference to where the dress code regulations can be found will be included on the registration form or will be included in the registration confirmation sent to registrants in advance of the Event. If the Organizing Committee has a website, the dress regulations will be posted.

**APP3.11.4.4 Guests**

(See Article 2.2.10, Book 1 re Guests)

Guests may register and shoot with competitors.

**APP3.11.4.5 Coaches**

All coaches must register for the event (see [AC 3.7.3](#)).

**App3.11.4.6 Agents**

While archer's agents do not have to pre-register for the event, they must obtain accreditations with their name and the archer's name for whom they are the agent on the accreditation and meet the dress code requirements.

**APP3.11.5 Officials**

**APP3.11.5.1**

A Director of Shooting will be appointed by the Organizing Committee with the agreement of the Technical Delegate.

**APP3.11.5.2**

Officials for receiving and posting scores will be appointed by the Organizing Committee.

**APP3.11.5.3**

Archery Canada will appoint a Technical Delegate who will, together with other duties (ref [AC 3.5.4.1., Book 2](#)):

- monitor results reporting and ensure that correct results are posted.

**APP3.11.5.4**

The Tournament Judge Commission will consist of a minimum of four (4) judges.

- Archery Canada will appoint three (3) judges; one will be a National level or higher judge, and the other two National Judge Candidate level or higher.
- The remainder of the commission, appointed by the Organiser, will be Provincial level or higher judges.

**APP3.11.6 Team Officials**

Refer to AC 18 Team Officials – Canada, Book 3

**APP3.11.7 Practice**

See Book 3, Chapter 16, [Article AC 16.1.2](#).

**APP3.11.8 Program and Protocol**

To be Developed.

**APP3.11.9 Target Assignments****APP3.11.9.1**

In the Qualification Round, athletes will be grouped alphabetically by last name within the category where this is feasible.

**APP3.11.9.2**

The Organizers may make alterations to the assignments to meet the constraints of field layout etc.

**APP3.11.9.3**

A list of athletes, according to target/group order and alphabetical order, must be distributed to all Officers, Judges, Athletes and Officials before the first day of the competition and each day during the competition.

**APP3.11.10 Venue, Equipment and Facilities****APP3.11.10.1**

The Field of Play shall be set up consistent with [Chapter 7](#).

**APP3.11.10.2**

The Organizing Committee will provide adequate shelter against the weather for athletes and their equipment.

**APP3.11.10.3**

Adequate toilet facilities for women, men, and wheelchairs will be provided within a reasonable distance of the shooting field or along the ranges.

**APP3.11.10.4**

The Canada Cup may be held on an open field, in an open arena, or in a stadium.

**APP3.11.10.5**

Seating accommodations for all athletes and Team Officials will be made available close to the waiting line. Sheltered seating will be provided for Judges at the waiting line.

**APP3.11.10.6**

The Director of Shooting will be positioned at a raised platform situated on the shooting line at the separation between parts of the field or on either end.

**APP3.11.11 Dignitaries and Media****APP3.11.11.1**

Dignitaries are Archery Canada Representatives, Sponsor Representatives, Archery Canada Board of Directors members, and others as designated by the Archery Canada Board of Directors or the Organizing Committee.

**APP3.11.11.2**

Dignitaries may enter the athlete area as long as a Judge escorts them.

**APP3.11.12 Dress Regulations**

Refer to Section 20, Book 3

## APPENDIX 1 - WORLD RANKING TOURNAMENTS

### MINIMUM STANDARD CRITERIA

#### 1.1.

Access for all athletes and their sports equipment into the country.

#### 1.2.

Minimum of one World Archery Judges or CJ appointed.

#### 1.3.

Technical Delegate inspection and review. A complete report shall be sent to the Continental Association endorsing the event and to World Archery events department.

#### 1.4.

Tournament endorsed and guaranteed by the respective Continental Association. World Archery shall receive the application from each respective Continental Association for final approval.

#### 1.5.

The organisers shall use a registration system approved by World Archery in order to collect the necessary data for each athlete such as:

- ID number;
- Name (Family name, First name);
- Category;
- Date of birth (DD/MM/YYYY);
- Member Association acronym.

#### 1.6.

The results shall be live (through World Archery Website or other website in agreement with World Archery. Live being as soon as the results are entered in an electronic system) from the Qualification Round onwards and include each individual arrow value in the World Archery required format (Olympic Data Feed or World Archery result system) and have been supervised by an official (results verifier or chairman of judges) at the tournament. The results shall be sent to the World Archery Office no later than 2 days after the tournament in electronic format.

#### 1.7.

For the Finals round scoring will be done by an automated scoring system approved by World Archery. The use of this is mandatory for all events that are Olympic Qualifiers at Multisport Games as well as Paralympics.

### SUBMISSION OF WORLD RANKING TOURNAMENTS

#### 2.1.

Member Associations shall apply for World Ranking Tournaments via their respective Continental Association on the appropriate form. No other form of application shall be accepted.

#### 2.2.

The Continental Association shall then submit the tournament application duly completed (including nomination of a Technical Delegate, a Chairperson of Judge Commission, and Results Manager) to the World Archery Office at least six months prior to the date of the World Ranking Tournament which shall then be reviewed by the World Archery events department.

#### 2.3.

The Executive Committee shall finalise the calendar.

## WORLD RANKING STATUS

### 3.1.

Automatic World Ranking status shall apply to Olympic Games and World Championships and World Cup stages.

### 3.2.

For tournaments which are not automatically recognised, it is recommended that the chairperson of the Tournament Judge Commission is not from the host Member Association. The remainder of the Tournament Judge Commission can be National, Continental or World Archery Judges from the applying Member Association. Appointments from outside the Member Association shall be arranged by the Continental Association in liaison with the Judges Committee.

### 3.3.

It is mandatory to appoint a Technical Delegate.

The costs for the preliminary and subsequent visits by the Technical Delegate shall be paid by the Continental Association or, if the Continental Association refuses, the organisers. In either case, no costs can be charged to World Archery.

### 3.4.

It is mandatory that the programme used for the results management be the official World Archery results system.

### 3.5

The World Ranking status of a tournament shall be removed after the completion of the event for the following reasons, but not limited to:

- Failure to submit the results according to [Article 1.6.](#);
- Failure to submit the Chair of Judges report or Technical Delegate report no later than 14 days after the event is completed;
- Failure to respect World Archery rules applicable to that event (including but not limited to: use of non-foam targets, use of non-licensed target faces);
- Failure to comply with World Ranking requirements published on World Archery document database.

---

## APPENDIX 2 - OLYMPIC GAMES SPECIAL REQUIREMENTS

### DRESS REGULATIONS

See [Chapter 20 - Dress Regulations, Book 3](#).

### FIELD OF PLAY

See [3.20. Field of Play](#).



## APPENDIX 3 - MATCH PLAY CHARTS

MATCH PLAY CHART 1A (104 ATHLETES, BYES ARE PERMITTED)

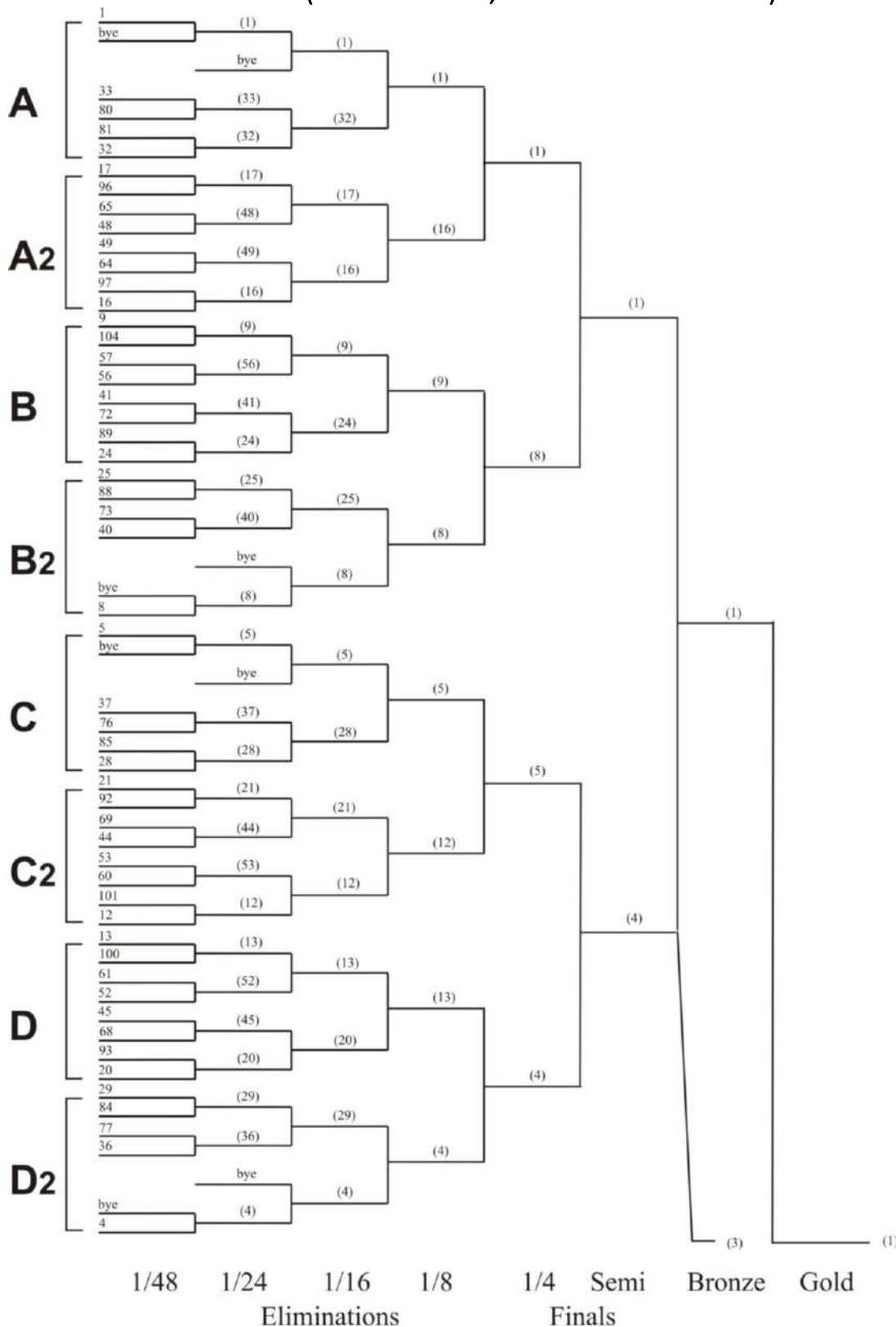

Image 9: Match Play Chart 1A (104 athletes, byes are permitted)

MATCH PLAY CHART 1B (104 ATHLETES, BYES ARE PERMITTED)

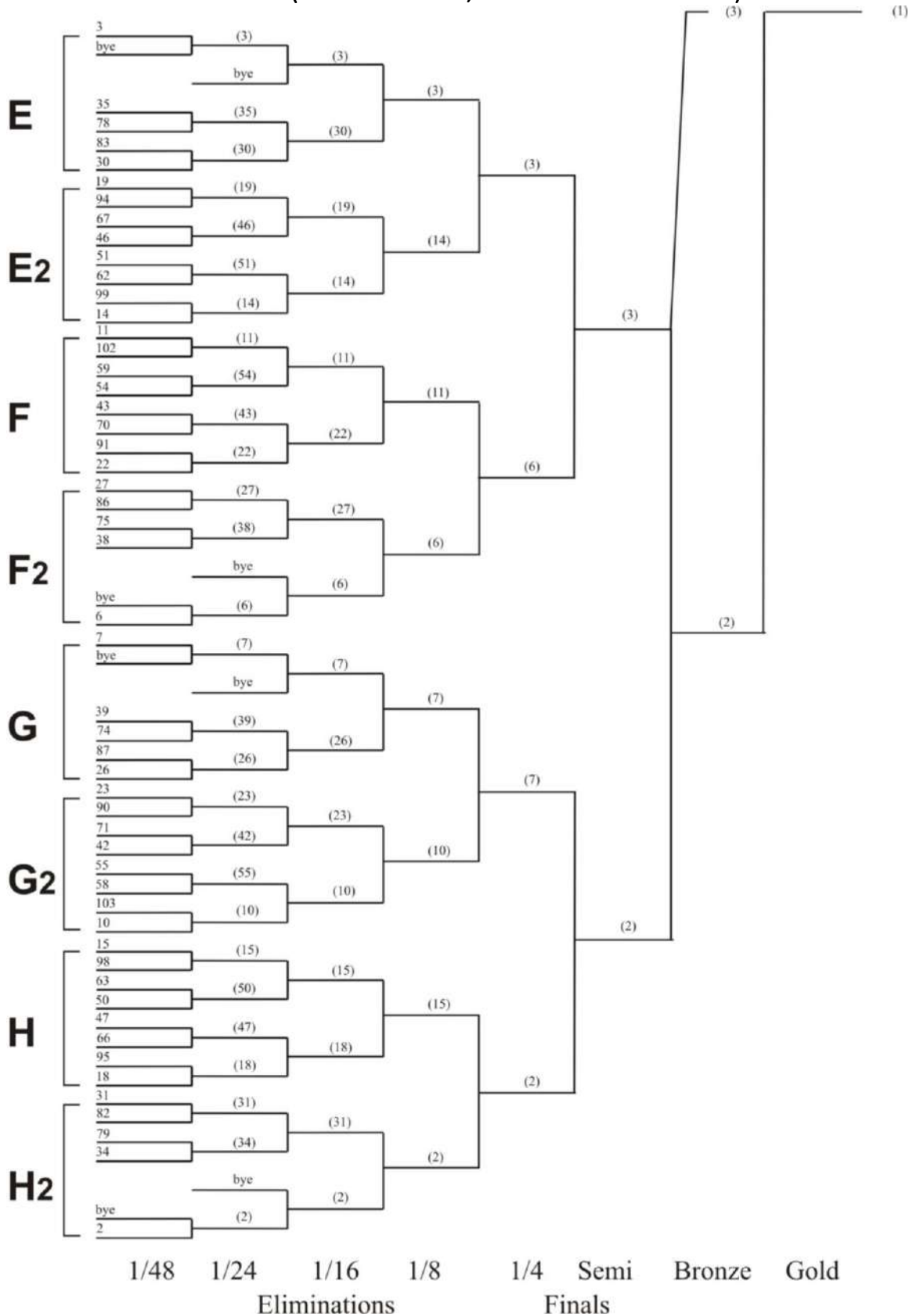

Image 10: Match Play Chart 1B (104 athletes, byes are permitted)

MATCH PLAY CHART 2 (64 ATHLETES, BYES ARE PERMITTED)

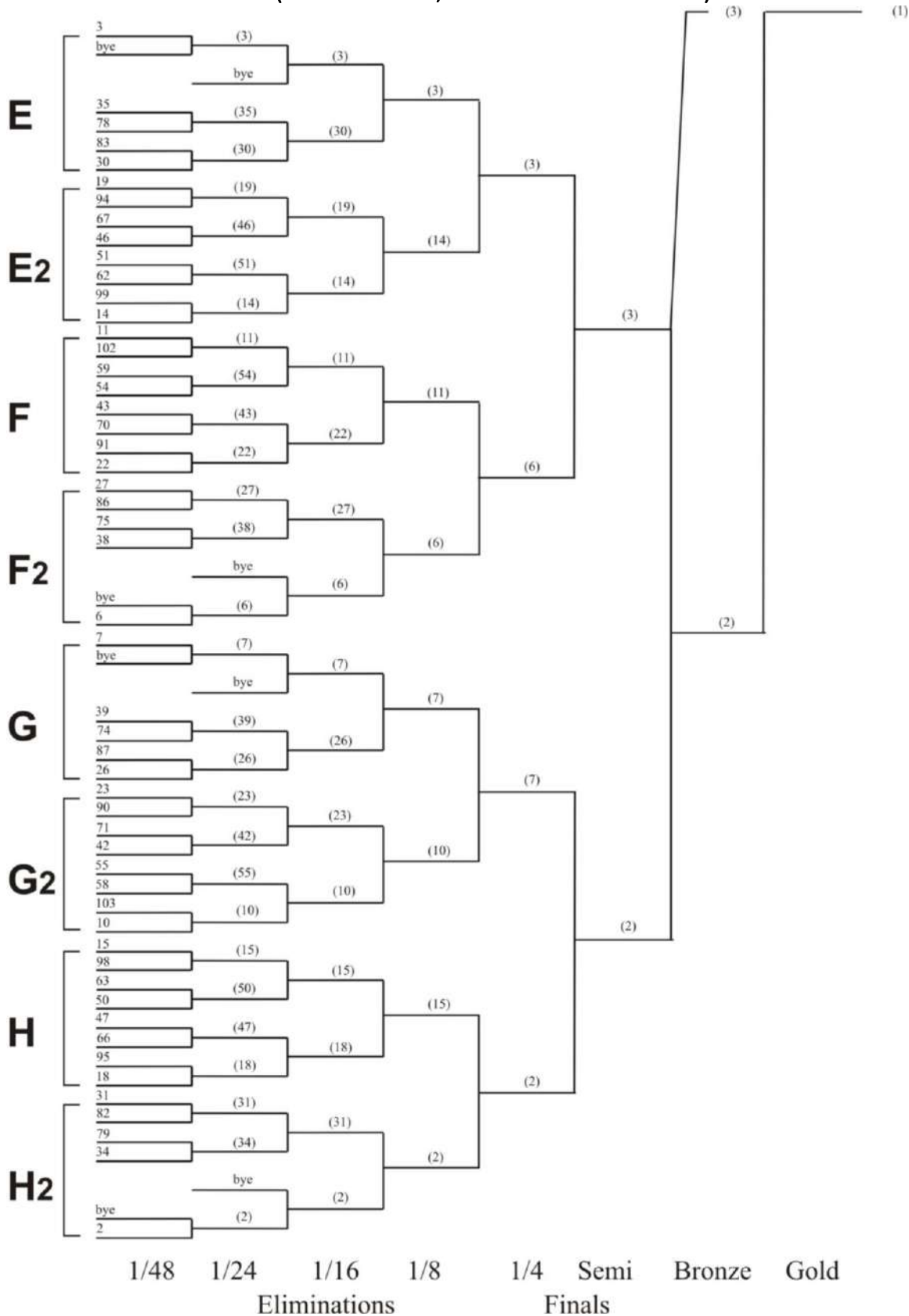

Image 11: Match Play Chart 2 (64 athletes, byes are permitted)

MATCH PLAY CHART 3 (32 ATHLETES, BYES ARE PERMITTED)

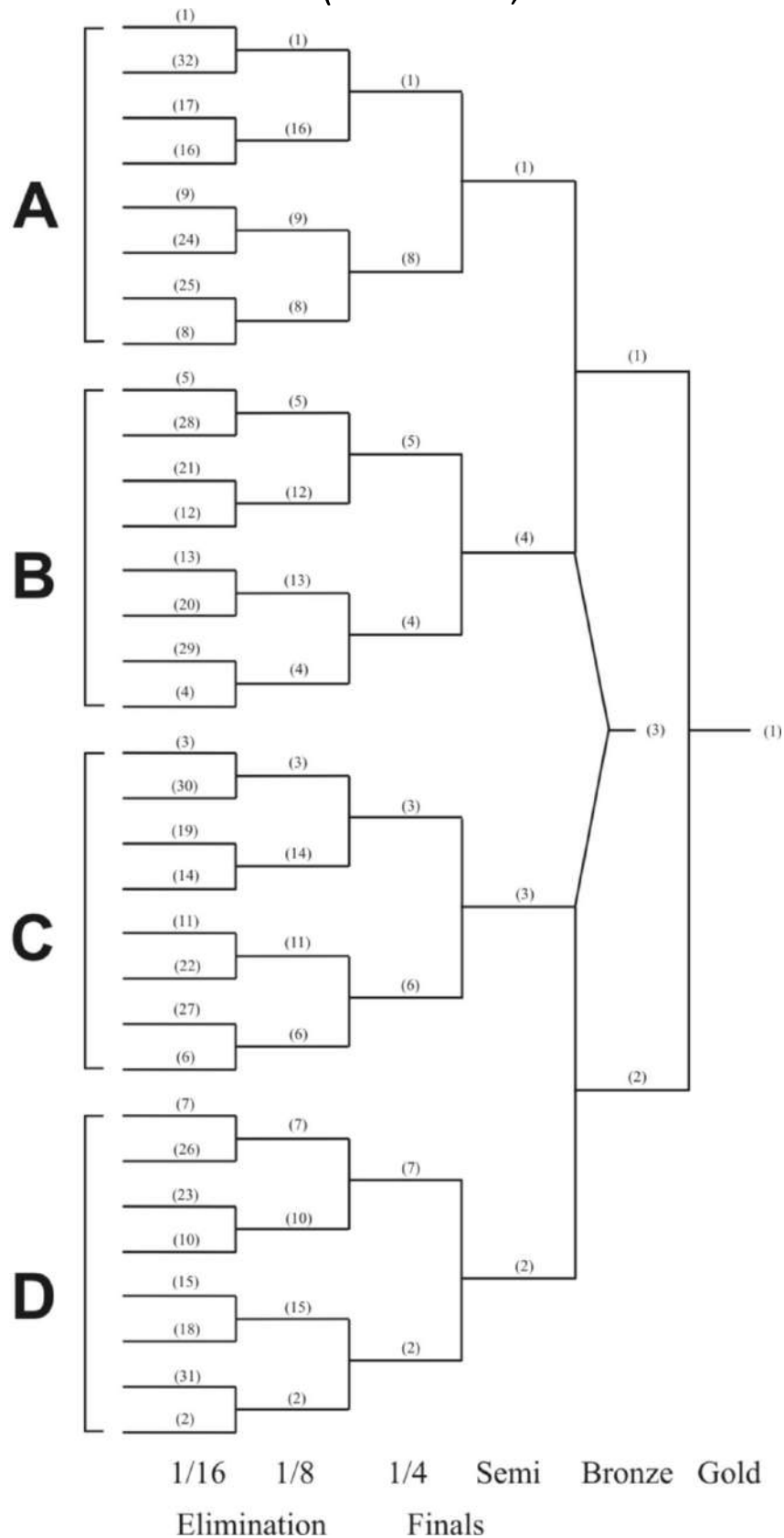
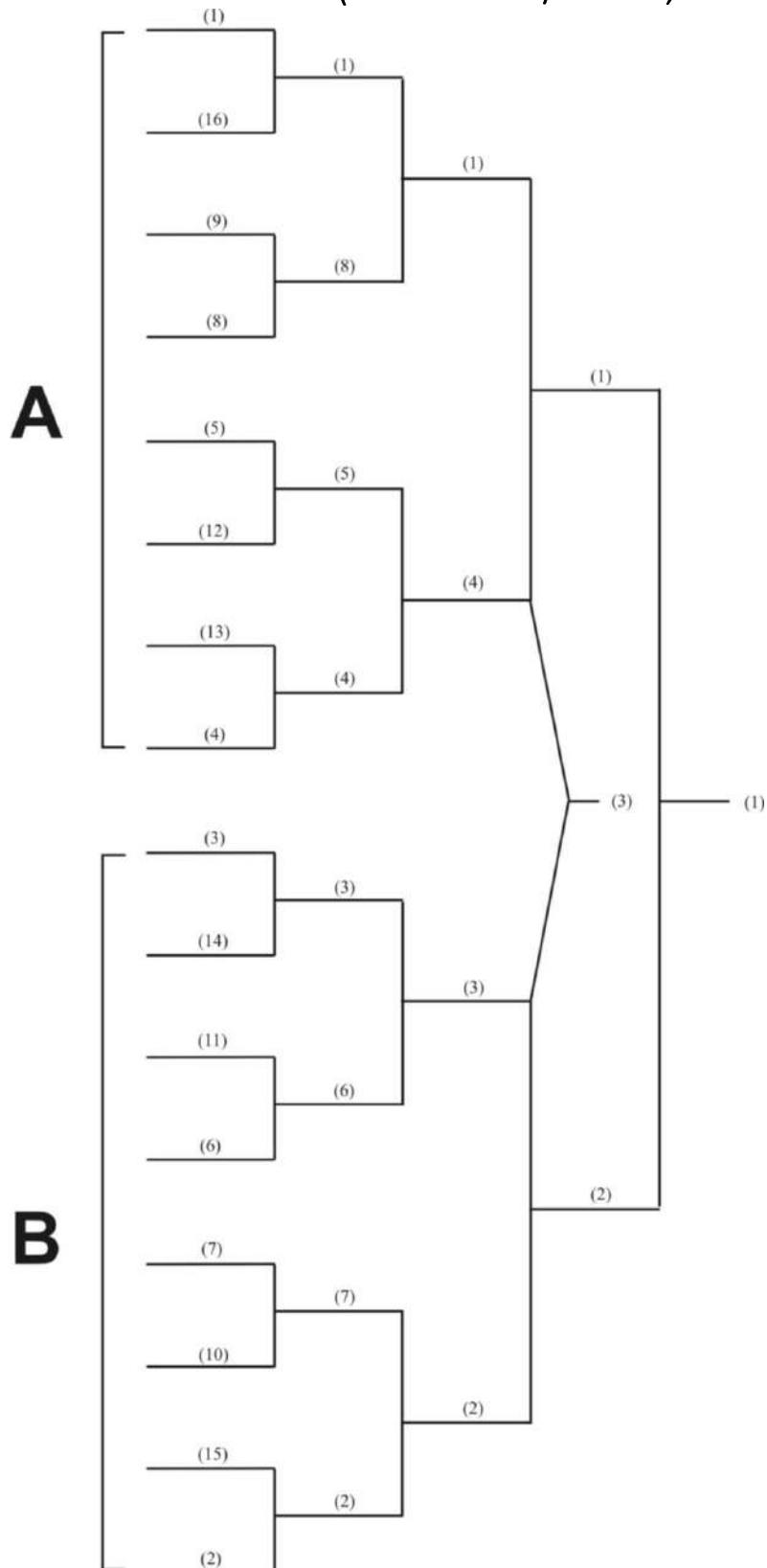

Image 12: Match Play Chart 3 (32 athletes, byes are permitted)

MATCH PLAY CHART 4 (16 ATHLETES / TEAMS, BYES ARE PERMITTED)



**Image 13:** Match Play Chart 4 (16 athletes / teams, byes are permitted)

OLYMPIC GAMES MATCH PLAY CHART (64 ATHLETES, BYES ARE PERMITTED)

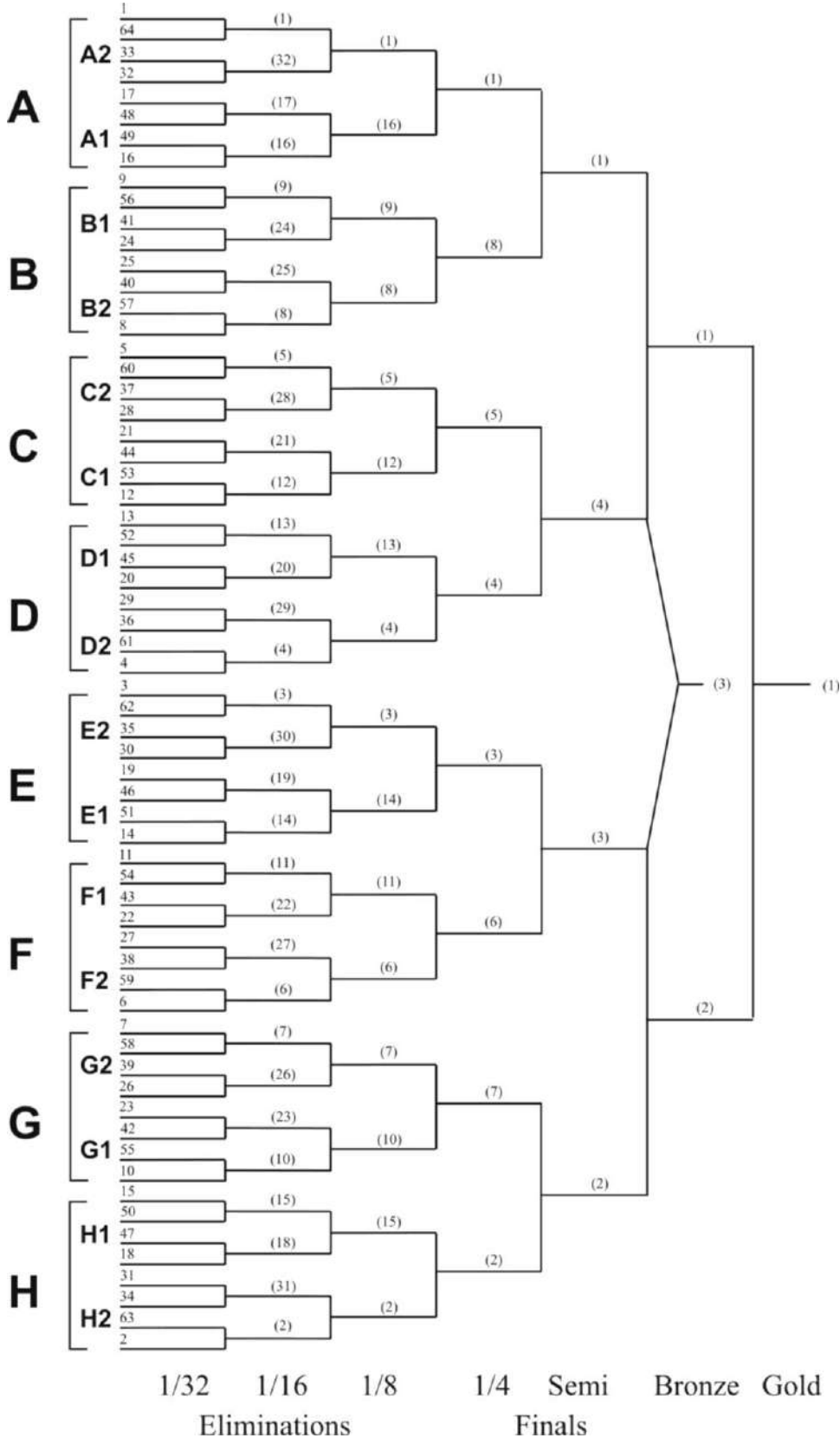

Image 14: Olympic Games Match Play Chart (64 athletes, byes are permitted)

MATCH PLAY CHART 5 (24 TEAMS, BYES ARE PERMITTED)

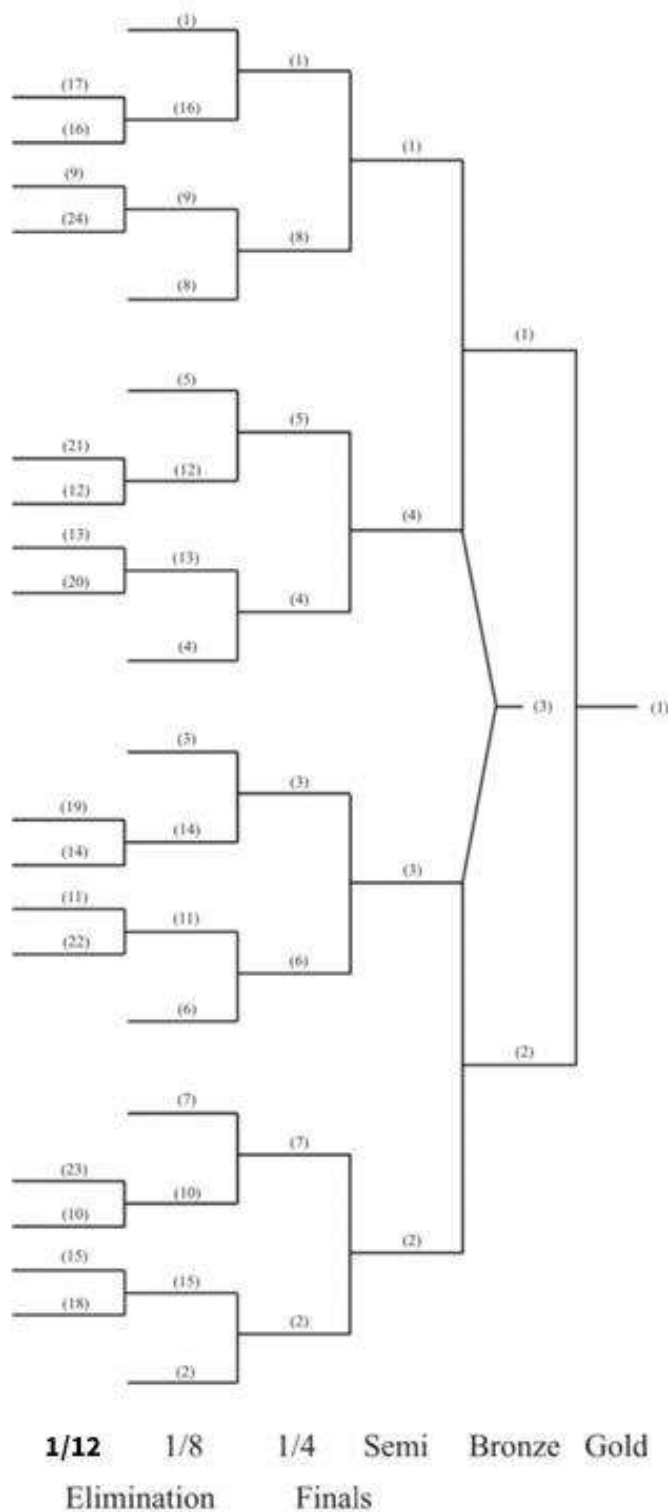

Image 15: Match Play Chart 5 (24 teams, byes are permitted)